

# WIRELESS TRANSMITTER DUOS uTEMP



Tekon Wireless Transmitter DUOS uTemp is the perfect temperature wireless solution for monitoring applications, automation and centralization of temperature measurements throughout the production substances, distribution and storage of refrigerated foods, frozen and deep-frozen, HVAC and other industry processes.

The universal temperature inputs allows to connect a large range of temperature probes like RTD's and thermocouples. It is also possible to measure linear mV and linear ohms.

#### Product References

	White
868MHz	PA210320120
915MHz	PA210320140

## KEY FEATURES

### MULTIPLE TEMPERATURE INPUTS

RTD, THERMOCOUPLES, LINEAR OHM AND MV

### DIGITAL INPUT EVENT TRIGGER COMMUNICATION

### WIRELESS LINK STRENGTH (RSSI)

AUTO DISCOVERY OF THE BEST WIRELESS LINK

### LOW POWER AND LONG BATTERY LIFE

MEASURING AND TRANSMITTING BATTERY VOLTAGE

### WATER RESISTANT

IP67 PROTECTION

\* The temperature measurement sensor range is related with the external temperature probes.

DS\_DUOS\_UTEMP\_E01C

**TECHNICAL SPECIFICATIONS**

RADIO SPECIFICATIONS	868MHZ	915MHZ
Range <sup>1</sup>	Up to 4 Km LoS	
Minimum communication distance	3 m @ 27 dBm (500mW)	
Radio transmit power <sup>2</sup>	0 to 27 dBm	8 to 27 dBm
Radio receiver sensitivity <sup>2</sup>	-97 to -110 dBm	
Frequency band <sup>2</sup>	868 to 869 MHz	902 to 928 MHz <sup>4</sup>
Radio channels	16	50 <sup>5</sup>
Radio transmission rate <sup>2</sup>	1,2 to 76,8 kbit/s	
Modulation	GFSK	2-FSK
Encryption method	AES 128 (Advanced Encryption Standard)	

**WIRELESS NETWORK**

Maximum devices	55
Maximum hops	13
Communication period	1 to 43200 seconds (configurable)

**TEMPERATURE MEASUREMENT  
INTERNAL PROBE**

Range	-40 to 60°C
Resolution	0,1 °C
Accuracy	Typical: ± 0,25 °C / Maximum: ± 0,5 °C
Sensor type	I2C digital sensor
Response time	1 second

**TEMPERATURE MEASUREMENT  
EXTERNAL PROBE - RESISTANCE THERMOMETER (RTD)**

Measured variable	Temperature
Sensor type <sup>1</sup>	PT100, PT500, PT1000
Connection <sup>2</sup>	1 Resistance thermometer (RTD) in 2, 3 and 4-wire system
Units	°C
Sensor current	200 µA
Open-circuit monitoring	Always active (cannot be disabled)
Short-circuit monitoring	Always active (cannot be disabled)
Measuring range	Not configurable (See "Measuring Accuracy" table)
Characteristic curve	Temperature-linear
Cable resistance per wire (max.)	50 Ω
Effect of sensor cable resistance	< 0,0015 Ω / Ω - 3 wires < 0,0005 Ω / Ω - 4 wires

**TEMPERATURE MEASUREMENT  
EXTERNAL PROBE - THERMOCOUPLES (TC)**

Measured variable	Temperature
Sensor type	Thermocouples C, J, K, N, R, S, T
Units	°C
Connection	1 Thermocouple (TC)

Sensor current diagnostic	<11 $\mu$ A
Open-circuit monitoring	Always active (cannot be disabled)
Short-circuit monitoring	Not available
Cold junction compensation (CJC)	Integrated resistance thermometer
Measuring range	Not configurable (See "Measuring Accuracy" table)
Characteristic curve	Temperature-linear

#### RESISTANCE-BASED SENSOR (R)

Measured variable	Resistance
Sensor type	Resistance, Potentiometers
Connection	2 wires
Units	$\Omega$
Sensor current	200 $\mu$ A
Open-circuit monitoring	Always active (cannot be disabled)
Short-circuit monitoring	Always active (cannot be disabled)
Measuring range	Not configurable (See "Measuring Accuracy" table)
Characteristic curve	Resistance-linear

#### mV

Measured variable	DC Voltage
Sensor type	DC Voltage source
Connection	2 wires
Units	mV
Open-circuit monitoring	Always active (cannot be disabled)
Short-circuit monitoring	Not available
Measuring range	Not configurable (See "Measuring Accuracy" table)
Characteristic curve	Voltage-linear

#### MEASUREMENT ACCURACY

##### Reference conditions

Auxiliary power	4,5V DC $\pm$ 1%
Ambient temperature	23°C
Error due to internal cold junction	< $\pm$ 0,50 °C

##### Influence of ambient temperature

on RTD measurement	0,0042 °C/°C
on thermocouple	0,0027 °C/°C
on linear ohm	0,0016 $\Omega$ /°C
on linear mV	0,0002 mV/°C

EMC - immunity influence (IEC 61326-1)	PT100 - < 0,14 °C Thermocouple K - < 0,64 °C
Extended EMC immunity (NAMUR NE 21, A criterion, burst)	PT100 - < 0,10 °C Thermocouple K - < 0,20 °C

#### DIGITAL INPUT - ELECTRICAL AND TIME FEATURES

Contact type	Dry contact
Standby state	Open / OFF
Current consumption	DI ON: 28uA / DI OFF: 0uA

Communication time after DI activation	< 1,1 seconds
DI debounce time	60ms
Edge trigger	Open Close
DI event buffer	8

**POWER SUPPLY**

3x1,5 V AA lithium/alkaline/Ni-MH batteries <sup>3</sup>
External power supply with 5 VDC ± 5%
Peak current draw of 250 mA <sup>2</sup>
Supply voltage measurement accuracy ± 1 V DC
Sleep mode current consumption < 40 µA

**INTERFACE**

2 blue LED (LED 1 and LED 2) for wireless network address identification and general operation status
1 red LED (LED 4) and 1 green LED (LED 3) for wireless network operation status
1 magnetic reed switch for system reboot
1 M8 female socket with 5 poles for device configuration through host computer
1 M8 female socket with 4 poles for sensors

**OPERATING ENVIRONMENT**

Temperature range	-40 to 60°C
Humidity	95% maximum relative humidity (non-condensing)

**CASING**

Dimensions	162 x 88,5 x 25 mm
Weight	100 g
Material	ABS UL94HB
Protection index	IP67

FACTORY DEFAULT SETTINGS	868MHZ	915MHZ
Frequency (MHZ)	869,525 MHz	915,000 MHz
Radio transmit power	27 dBm	
Radio transmission rate	76,8 kbits/s	
Wireless channel	13	26
Transmitter ID	1	
Sensor type	PT100 3 wires	
Communication period	10 seconds	
Configuration time window at startup	10 seconds	
Reconnection period	30 minutes	
Wireless network ID	16777217	

**CERTIFICATIONS AND APPROVALS**

EN 301 489-1 V2.2.1
---------------------

<sup>1</sup> Range depends on the RF propagation environment and Line of Sight (LoS). Always verify your wireless network's range by performing a Site Survey.  
<sup>2</sup> Dependent on radio channel selection.  
<sup>3</sup> Batteries not included.  
<sup>4</sup> In some countries, the frequency band admitted is not so extended as the default range.  
<sup>5</sup> The radio frequencies admitted in Australia are available from channel 26 to channel 50.

## MEASURING ACCURACY

## RESISTANCE THERMOMETER (RTD)

SENSOR	RANGE °C	ACCURACY °C
PT100	-200 to 850	< ± 0,2
PT500	-200 to 850	< ± 0,2
PT1000	-200 to 850	< ± 0,2

## THERMOCOUPLES (TC)

SENSOR	RANGE °C	ACCURACY °C
C	0 to 2300	< ± 1
J	-210 to 1200	< ± 0,5
K	-270 to 1372	< ± 0,5
N	-270 to 1270	< ± 0,5
R	-50 to 1768	< ± 1
S	-50 to 1768	< ± 1
T	-270 to 400	< ± 0,5

## LINEAR SENSORS

SENSOR	RANGE	ACCURACY
Ohm	0 to 6000 Ohm	2 ohm
mV	-2000 to 2000 mV	1 mV

## BATTERIES

## RECOMMENDED BATTERIES

BRAND	ENERGIZER	PANASONIC	DURACELL	DURACELL
Model	Ultimate Lithium L91	Alkaline Power	MN1500	DX1500H
TME Part Number	BAT-FR6/EGL-B4	BAT-LR06/P-B4	BAT-LR6/DR-B12	ACCU-R6/2500/DR
Classification	Lithium	Alkaline	Alkaline	Rechargeable
Chemical System	Li/FeS <sub>2</sub>	Zn/MnO <sub>2</sub>	Zn/MnO <sub>2</sub>	Ni-MH
Nominal Voltage	1,5 V	1,5 V	1,5 V	1,2 V
Type	AA	AA	AA	AA
Operating Temperature	-40°C to 60°C	-20°C to 54°C	-20°C to 54°C	-10°C to 50°C

## VOLTAGE THRESHOLD (VDC)

INTERNAL TEMP. ≥ -10°

INTERNAL TEMP. &lt; -10°

Critical battery

3 V

2,5 V

PERFORMANCE TESTS

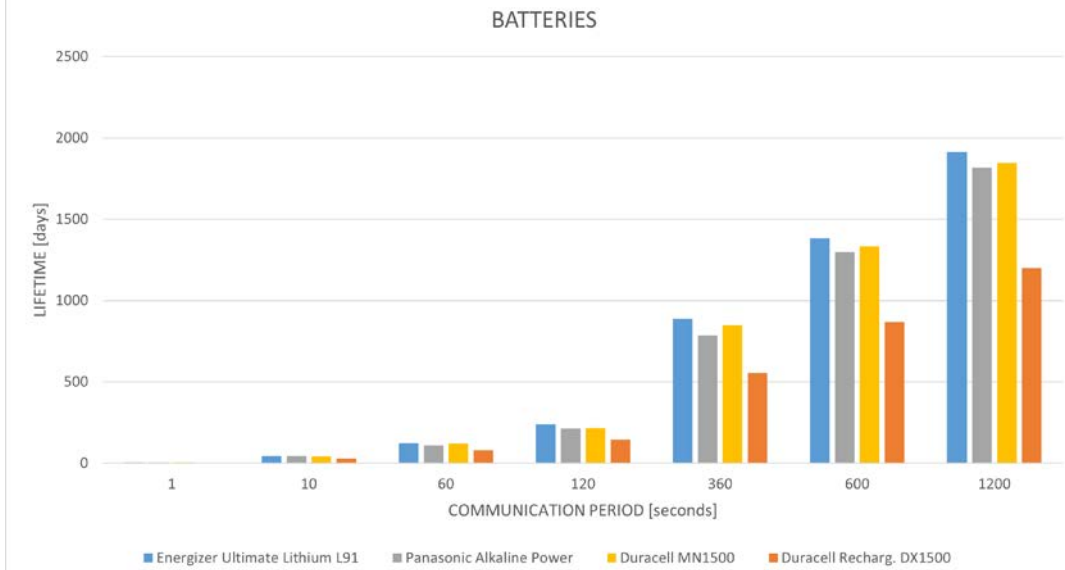

CALIBRATION SETTINGS

Linear Calibration ( $y=mx+b$ )\*

	m	b
External temperature	1 (default)	0 (default)
Internal temperature	1 (default)	0 (default)

\* Software configurable values

DIGITAL INPUT

TRANSMITTER DI OPERATION

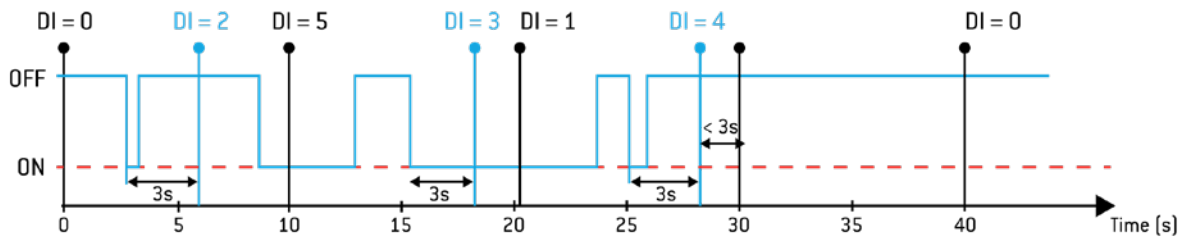

Warm up time = 3s  
Communication period = 10s

DI STATE / AWAKENED BY	Time	DI	DI+Time
OFF	0	2	4
ON	1	3	5

Note: If Communication Period value is between 1 and 3 seconds, possible values are: 0, 1, 4 and 5.

CONNECTION DIAGRAM

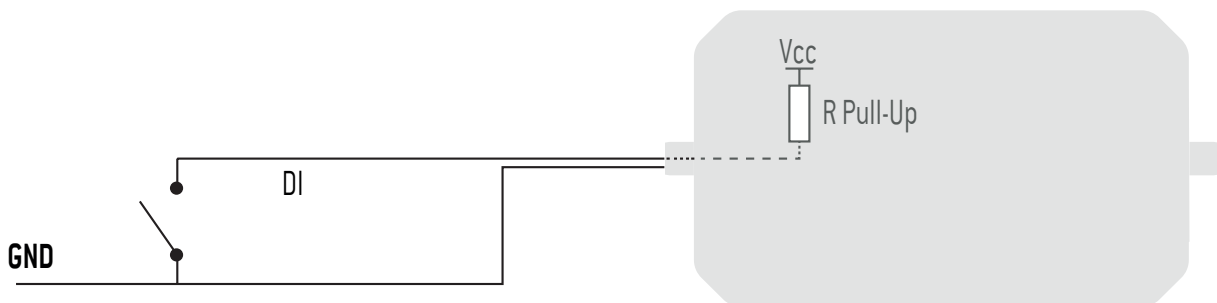

**RSSI LEVELS**

SIGNAL (DBM)	QUALITY
0 to -50	Excellent
-51 to -60	Good
-61 to -70	Acceptable
-71 to -100	Poor

**MAGNETIC SWITCH**

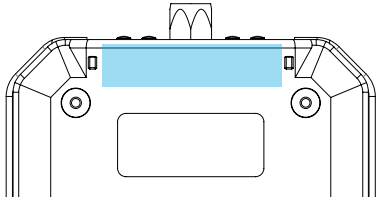

The DUOS Wireless Transmitters have a magnetic switch that allows to reset the devices.

**Operation Mode:**

Slide a magnet in the area marked in the image. All LED's will be active and the transmitter will be restarted.

**TECHNICAL DRAWINGS**

**DIMENSIONAL DRAWINGS AND INTERFACE DESIGN**

**M8X5P PINOUT DIAGRAM**

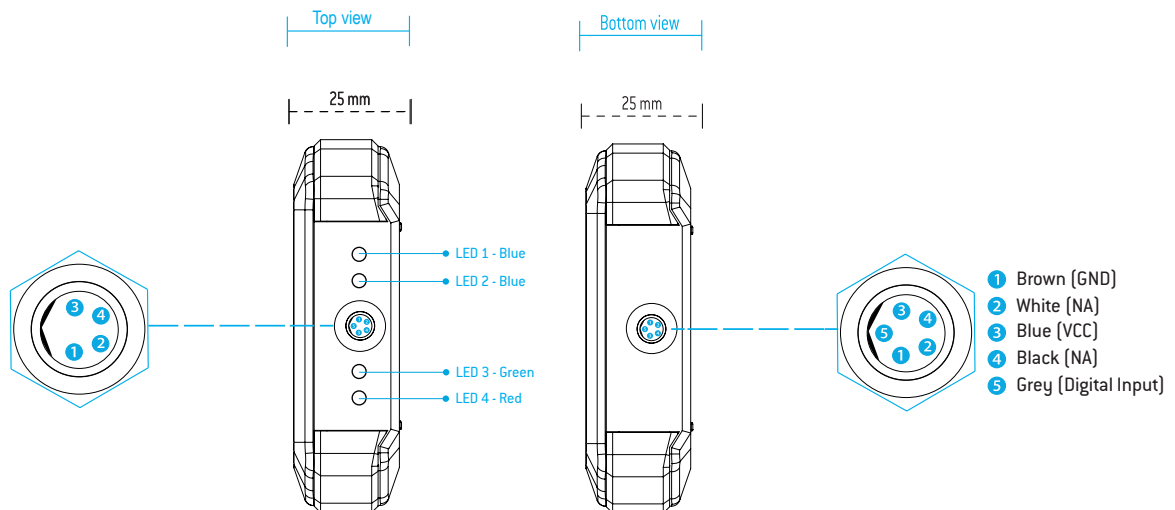
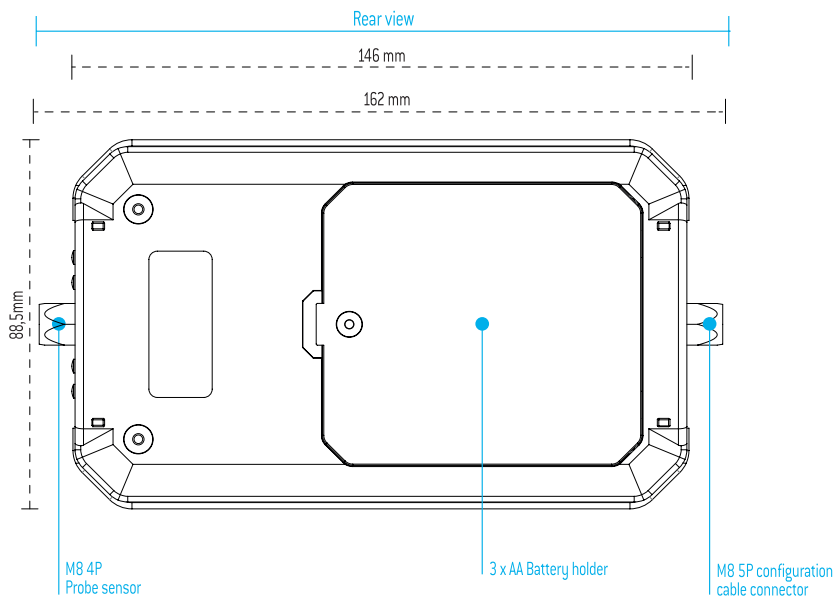

TEMPERATURE SENSORS (PROBE CONNECTOR)

RTD

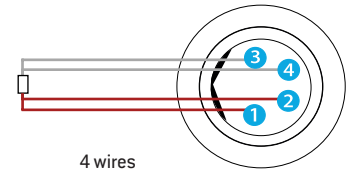
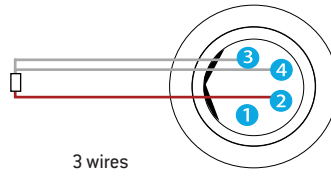
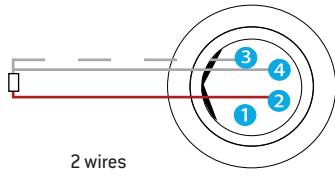

THERMOCOUPLES

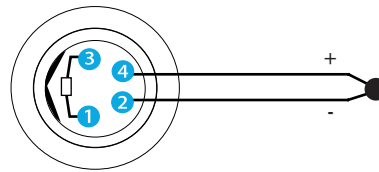

NTC cold-junction compensation

LINEAR SENSORS

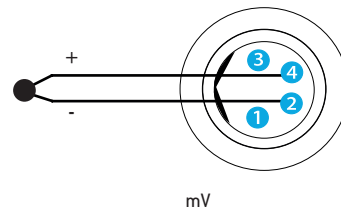
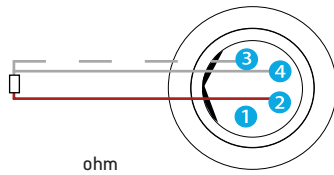

ACCESSORIES



**DUOS EXTERNAL POWER CABLE**

REF.: PA160410008

DUOS Transmitter external power supply cable.



**DUOS DI+TEMP EXTERNAL CABLE**

REF.: PA160410009

DUOS DI+TEMP Digital Input cable.



**DUOS TRANSMITTER SARC**

REF.: PA160410005

Cable used to configure DUOS Transmitter using Tekon Configuration software.



**DUOS POWER SUPPLY 230V AC / 5V DC**

REF.: PA160413610

230V/50Hz Power supply cable to be used with DUOS wireless transmitters.



**DUOS M8 MALE CONNECTOR WITH NTC**

REF.: PA160413710

M8 connector M8 of temperature probe.



## REVISION HISTORY

## VERSION

E01B	Simplification of the connection diagram for thermocouple sensors. Note about connecting temperature sensors to the connector. Introduction of probe connector (PA160413710) as product accessory.
E01C	Inclusion of Reconnection Period on "Factory Default Settings Table"

© BRESIMAR AUTOMAÇÃO, S.A.

All rights reserved.

The contents of this document (texts, images, brands, corporate image, trade name, designs, methodological and product descriptions, among others), as well as its structure and design, are owned by Bresimar Automação, SA (herein in referred to as Bresimar) or, it has legitimacy for its use, being strictly prohibited the modification, exploitation, reproduction, communication to third parties or distribution of all or part of the contents of this document, without the prior express written consent of Bresimar .

Bresimar will not be liable for any claim, loss or damages resulting from or arising from a cause over which Bresimar has no control, whether by acts or omissions, breach of contract or non-compliance with applicable laws by the Supplier , as well as incidents caused by the client's systems.

TEKON ELECTRONICS  
a brand of Bresimar Automação S.A.

Avenida Europa, 460  
Quinta do Simão  
3800-230 Aveiro  
PORTUGAL

P.: +351 234 303 320  
M.: +351 933 033 250  
E.: sales@tekonelectronics.com

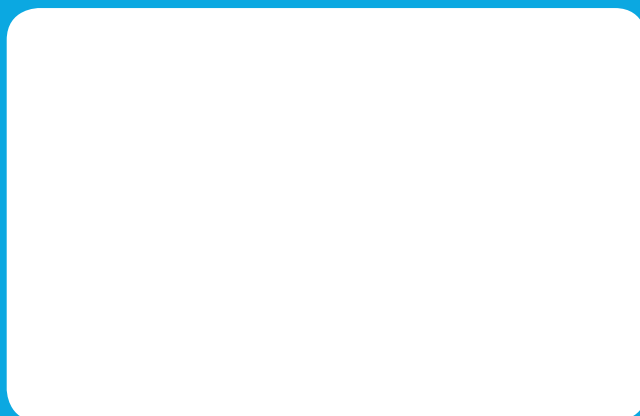

Cofinanciado por:



UNIÃO EUROPEIA  
Fundo Europeu  
de Desenvolvimento Regional