



DUOS WIRELESS SYSTEM INSTALLATION GUIDE

IG_DUOS_E02A

DUOS WIRELESS SYSTEM

INSTALLATION GUIDE

Table of contents

step
01 **CONNECT AND CONFIGURE THE DUOS WIRELESS GATEWAY**
Pages 4 to 15

step
02 **CONNECT AND CONFIGURE THE DUOS WIRELESS TRANSMITTER**
Pages 16 to 24

step
03 **CHECK WIRELESS COMMUNICATION BETWEEN THE DUOS TRANSMITTER AND THE GATEWAY**
Page 25 to 26

DUOS WIRELESS SYSTEM

INSTALLATION GUIDE

Table of contents

step
04 **CONNECT AND CONFIGURE THE DUOS WIRELESS REPEATER**
Pages 27 to 34

step
05 **CONNECT THE DUOS WIRELESS IOT GATEWAY**
Pages 35 to 49

LEGEND:



Important information for the setup;



Take note of the information;



Validation of a setting;

step
01

CONNECT AND CONFIGURE THE DUOS WIRELESS GATEWAY

step

01

CONNECT AND CONFIGURE THE DUOS WIRELESS GATEWAY



NOTE:

If your device is a DUOS IoT GATEWAY, please consider the information on this page. If your device is a DUOS GATEWAY, please go to the next page to start the equipment setup.

SYSTEM ARCHITECTURE

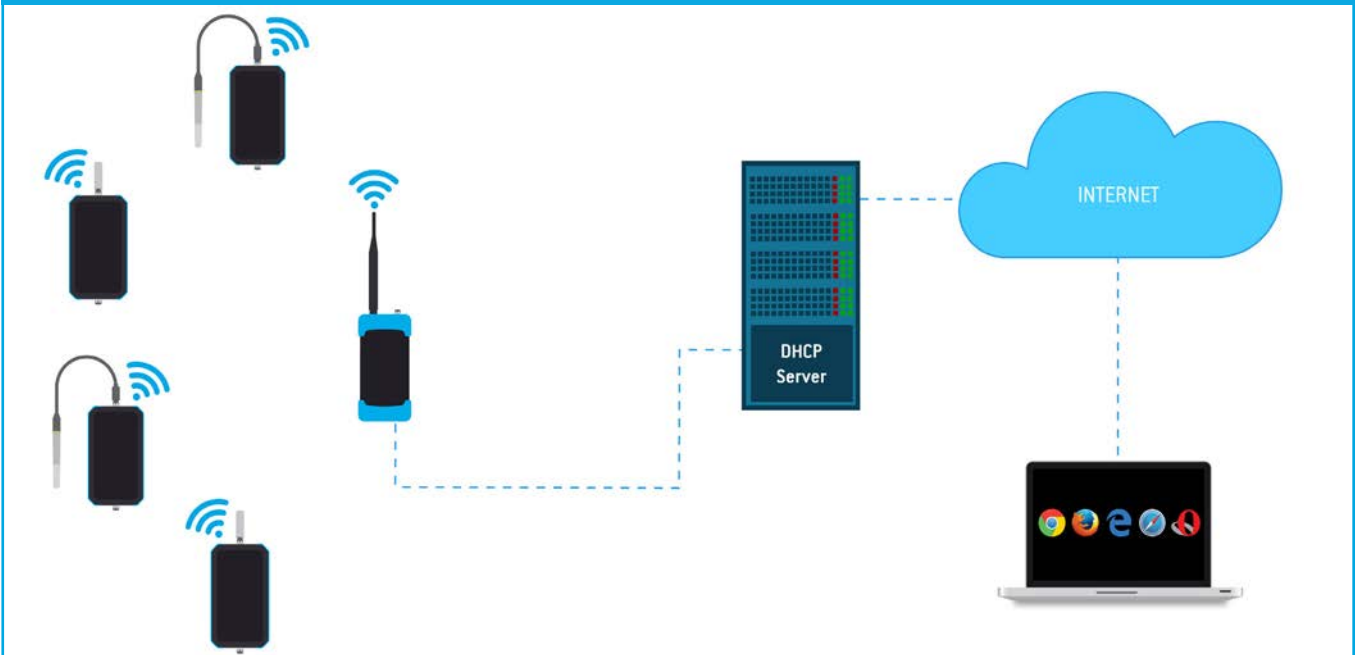

MINIMUM REQUIREMENTS

The right application of DUOS IoT GATEWAY only occurs if all minimum requirements are met by the customer side. The architectural minimum requirements needed to successfully use this device are:

- **Ethernet cable** (included with your DUOS IoT GATEWAY);
- **DHCP server;**
- **Web browser with the latest version;**

You must have a DHCP server in your network. The main purpose of this kind of server is to automatically provide and assign IP addresses and other networks parameters to connected devices.

To begin the configuration of DUOS IoT GATEWAY, the pin of button mode, must be in the *Config Mode* side.

After completing the setup procedures, go to [step 5](#) to begin the connection to the platform.



step

01

CONNECT AND CONFIGURE THE DUOS WIRELESS GATEWAY

TEKON CONFIGURATOR SOFTWARE is only compatible with the Microsoft Windows Operating System.

01

Connect the antenna to the *Gateway*.



02

Connect the *DUOS RS485-USB* cable to the computer and then to the Gateway.



03

Check the device connection through the LED signage.
If the red and blue LEDs are active, both the cable and *Gateway* are working correctly.

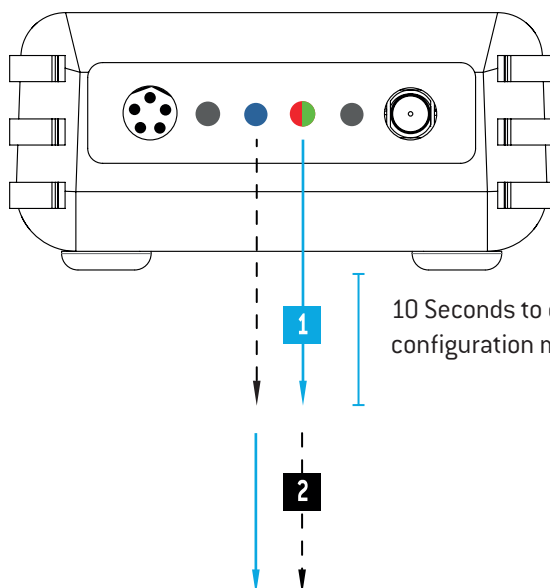

- LED flashes slowly
- 1** — LED switched on and steady
- 2** --- Red LED flashes every second whenever it sends beacons to new elements to join the network
- Green LED flashes as soon as the device receives data from other equipment.

step
01

CONNECT AND CONFIGURE THE DUOS WIRELESS GATEWAY

04

Open *Tekon Configurator Software*¹

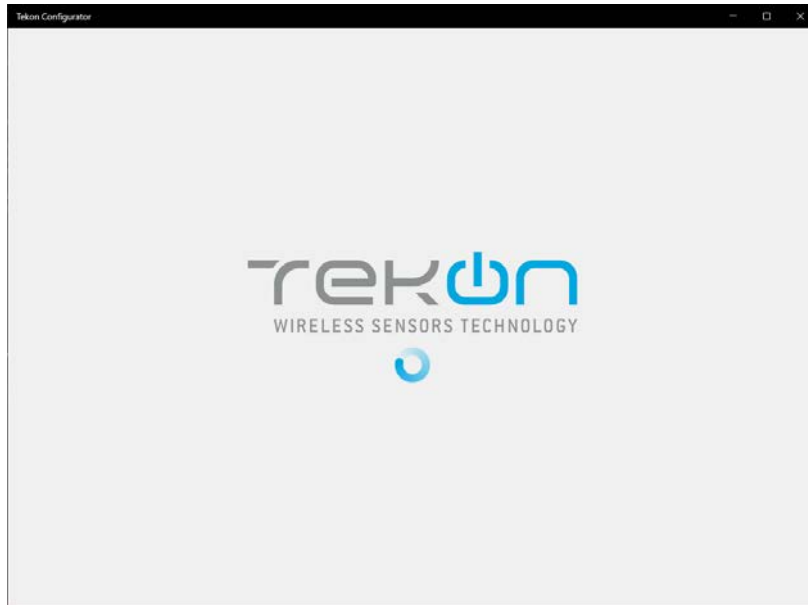

Open the DUOS Wireless Gateway device page.

You can enter the device's page in the following ways:

1st option: Click on "SMART TRANSMITTERS" in the left menu and then click on the WGW420 device.

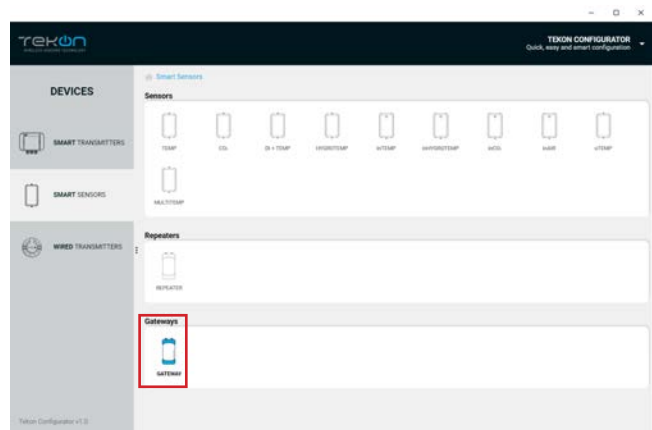
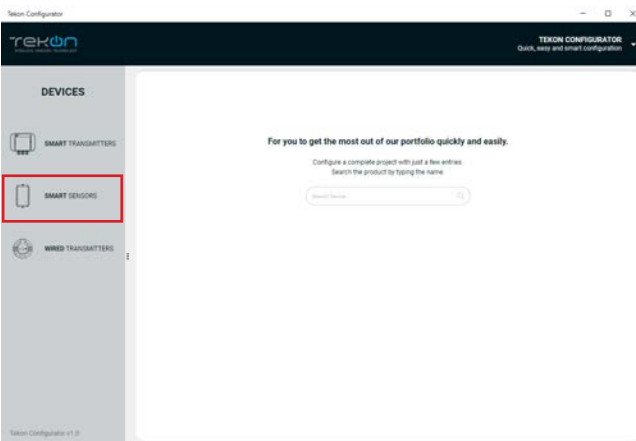

¹ Tekon Configurator software is free of charge and available at www.tekonelectronics.com

step

01

CONNECT AND CONFIGURE THE DUOS WIRELESS GATEWAY

2nd option: Type the name of the device in the “*Search Device*” field on the home page and select.

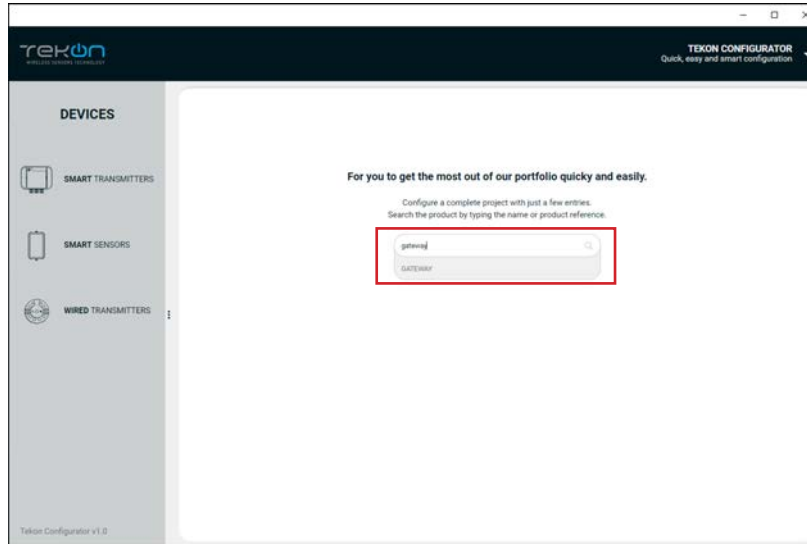

05

Load the “Port COM” corresponding to the DUOS Wireless Gateway.

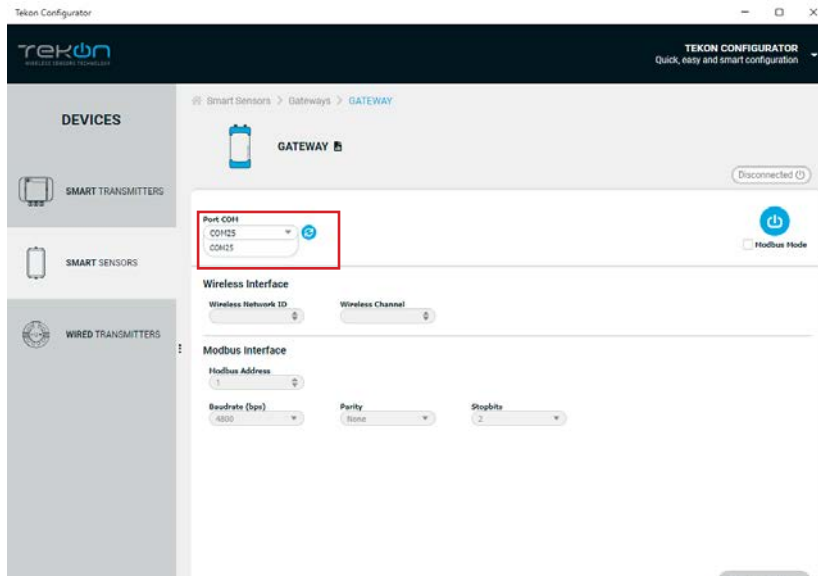

NOTE:



If the USB cable has already been connected before opening the device page, “Port COM” will appear in the list, otherwise you need to click on the “🔄” button.

step

01

CONNECT AND CONFIGURE THE DUOS WIRELESS GATEWAY

06

Select corresponding *Port name*².

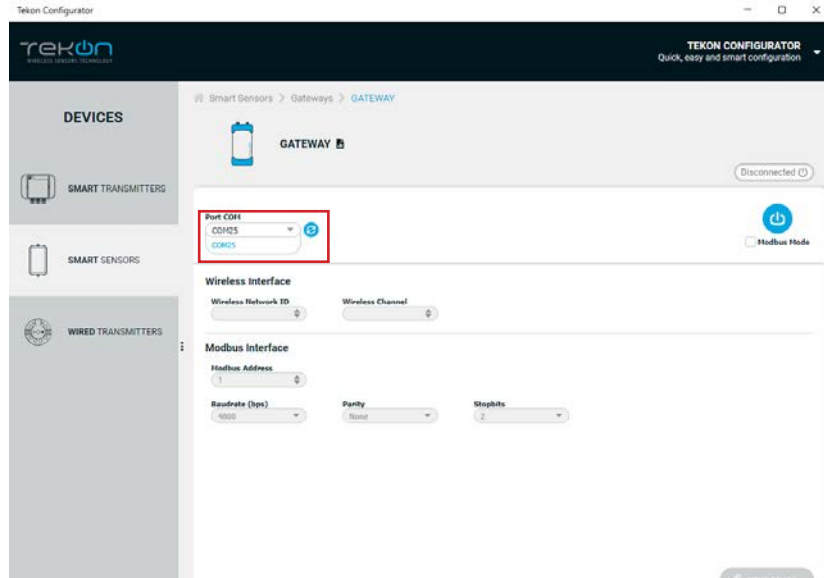

07

Remove the *DUOS RS485-USB* cable from the *Gateway* side and reinsert it.



NOTE:



After reinserting the cable, you have 10 seconds to enter in configuration mode by clicking on the Connect () button, while the blue LED flashes slowly. In this mode, you can manage the device parameters: *Modbus Address*, *Modbus baud rate*, *Modbus Parity*, *Wireless Network ID* and *Wireless Channel*.

² You can check device's serial port name in "Device Manager" on Microsoft® Windows® operating system.

step

01

CONNECT AND CONFIGURE THE DUOS WIRELESS GATEWAY

08

Click on *Connect* () button.

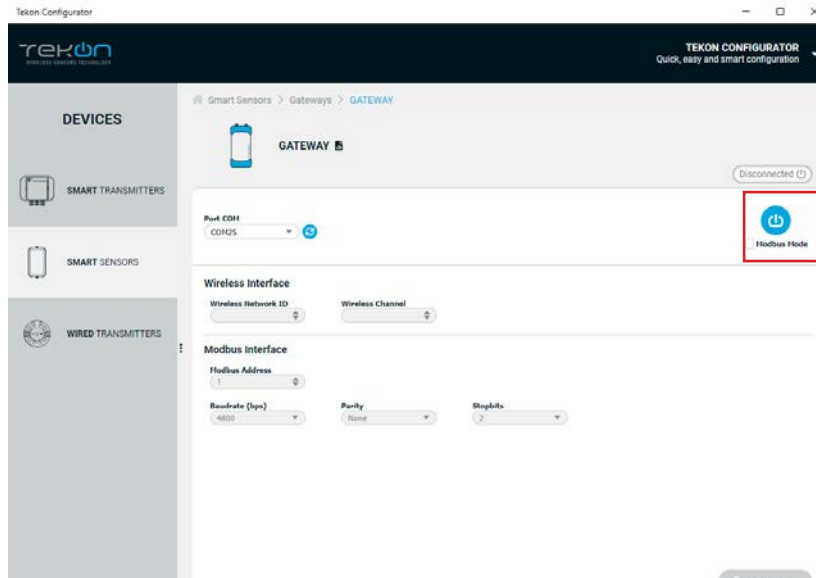

The software will connect to the device.

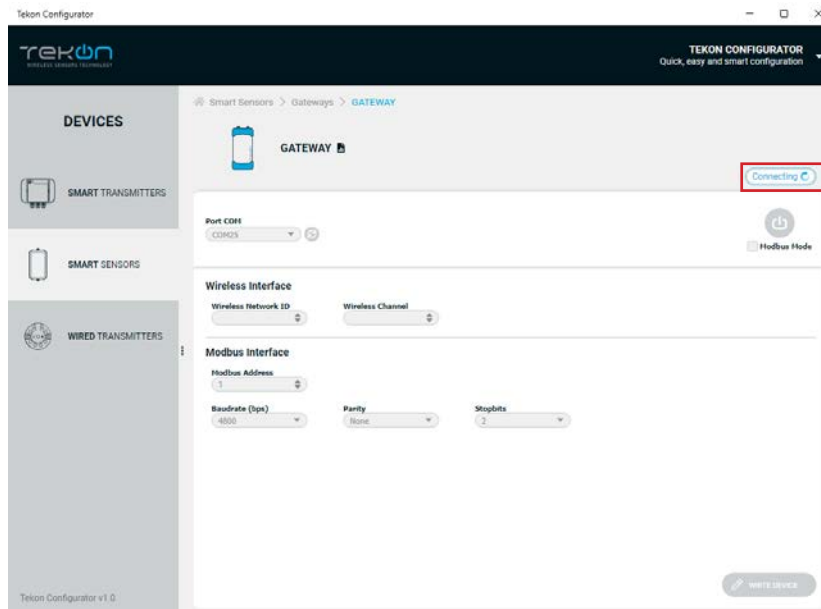

NOTE:



If the software is unable to connect to the device, the  status is displayed. If it hasn't connected, go back to the previous steps and check the port COM.

step
01

CONNECT AND CONFIGURE THE DUOS WIRELESS GATEWAY

When the software connects to the device, the “*Connected*” message will be displayed and the gateway will give feedback via LEDs.

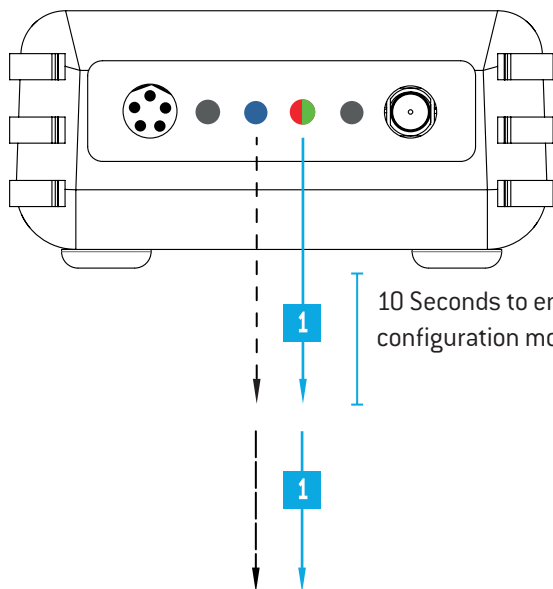
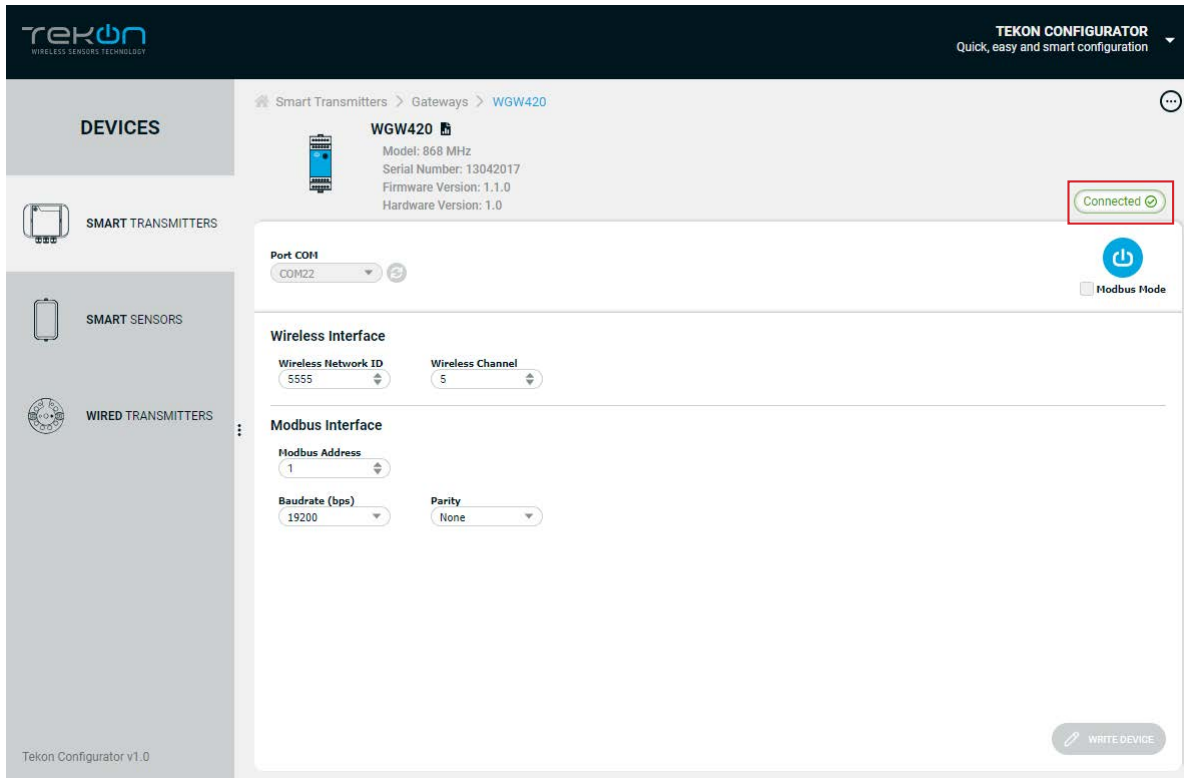

- LED flashes slowly
- - - LED flashes quickly
- 1** → LED switched on and steady



NOTE:

When 10 seconds have been exceeded, the blue LED is steady and it is no longer possible to enter configuration mode. In this case, the cable must be removed and reinserted - step 2.

step

01

CONNECT AND CONFIGURE THE DUOS WIRELESS GATEWAY

09

Take note of the device configuration data available, namely: *Modbus Address*, *Modbus Baudrate*, *Modbus Parity*, *Wireless Network ID* and *Wireless Channel*.

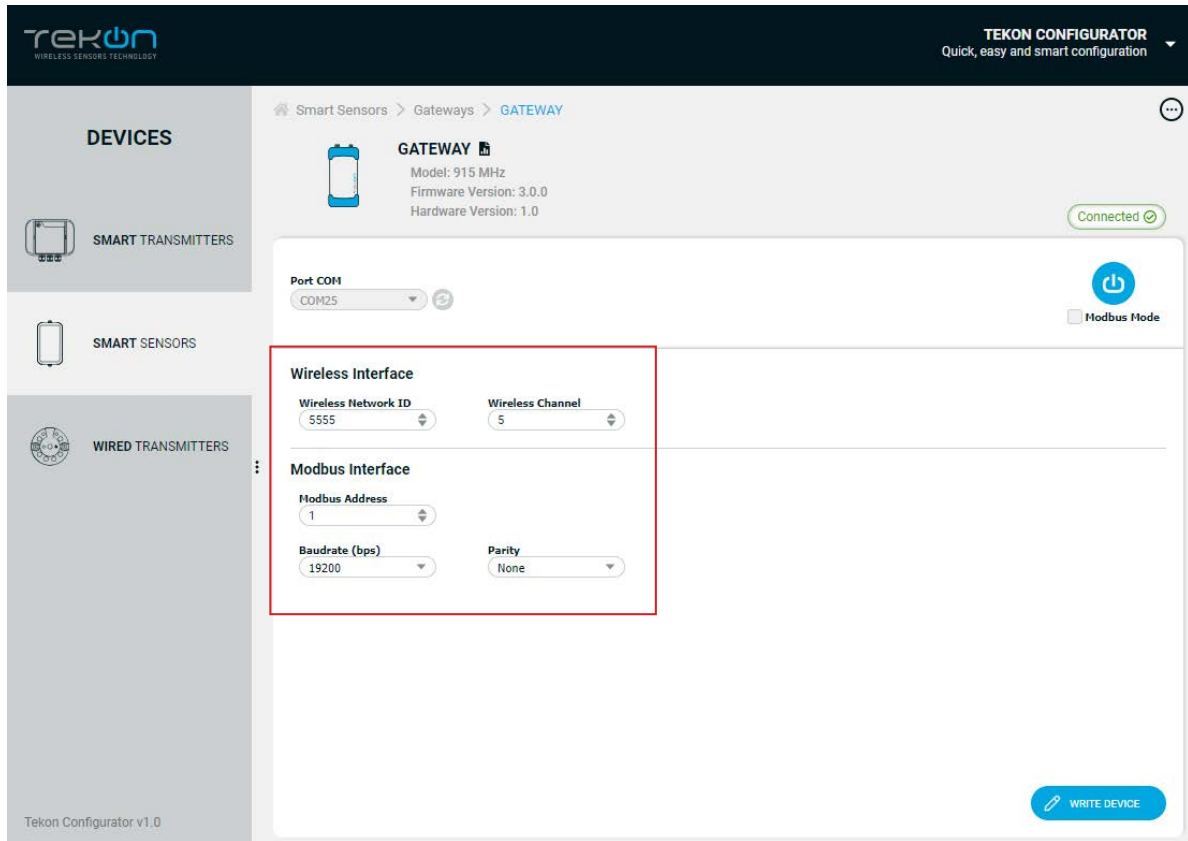

NOTE:

The wireless network connection between devices is ensured by the *Wireless Network ID* and *Wireless Channel* field parameters.

You can change the editable parameters. To save your changes, click on WRITE DEVICE. If the changes have been written to the device, the symbol (✓) will appear.

If not, the symbol (✗) will appear: try again and check that the device is connected correctly.

step
01

CONNECT AND CONFIGURE THE DUOS WIRELESS GATEWAY

10

Click on the *Disconnect* button.

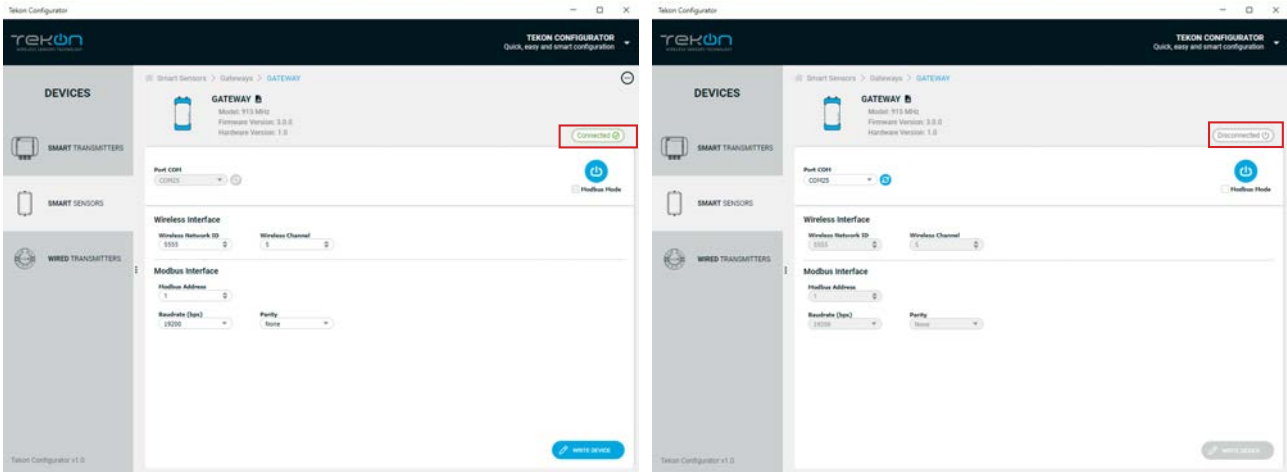

The “Connected” status changes to “*Disconnected*”.

The Modbus interface and the wireless network are active if the blue LED is on and steady and the red LED is flashing once per second.

11

Modbus Communication

Select modbus mode in the checkbox below the Connect button.

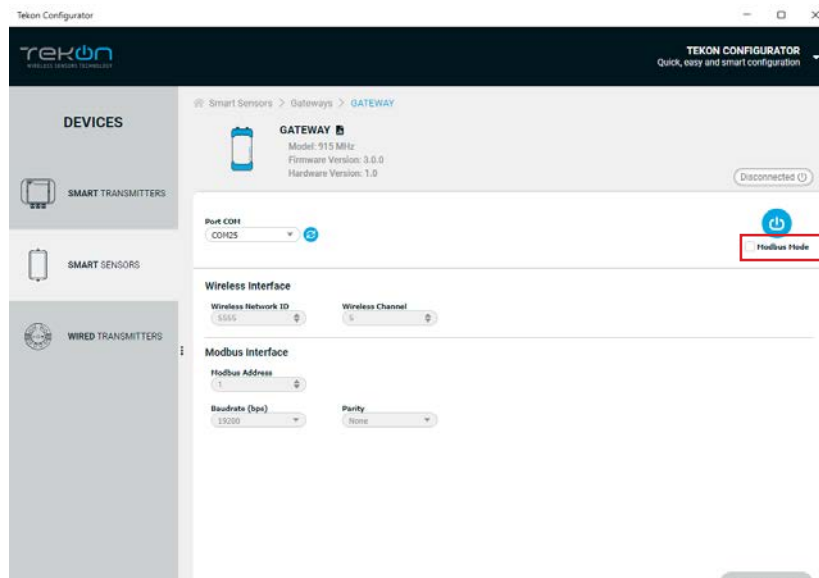

step
01

CONNECT AND CONFIGURE THE DUOS WIRELESS GATEWAY

12

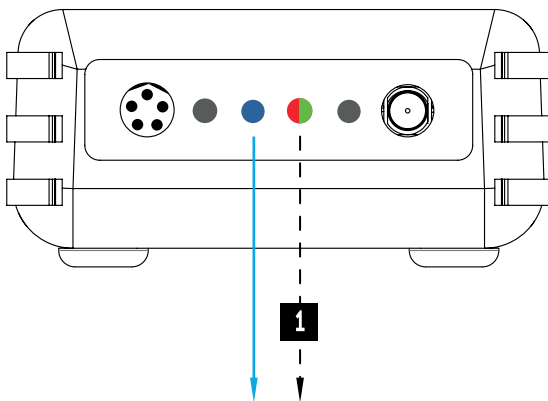
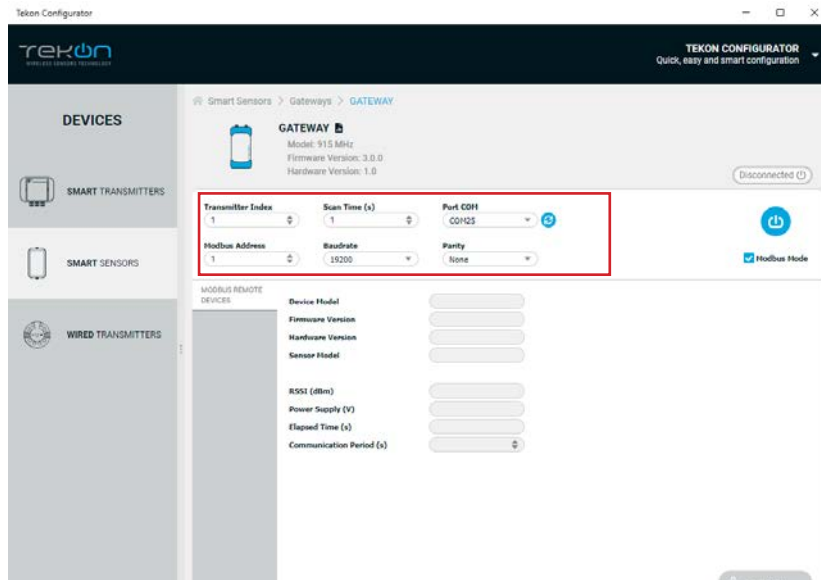

- LED switched on and steady
- 1** - - - Red LED flashes every second whenever it sends beacons to new elements to join the network.

step
01

CONNECT AND CONFIGURE THE DUOS WIRELESS GATEWAY

13

Click on connect and check that the status is “*Connected*”.

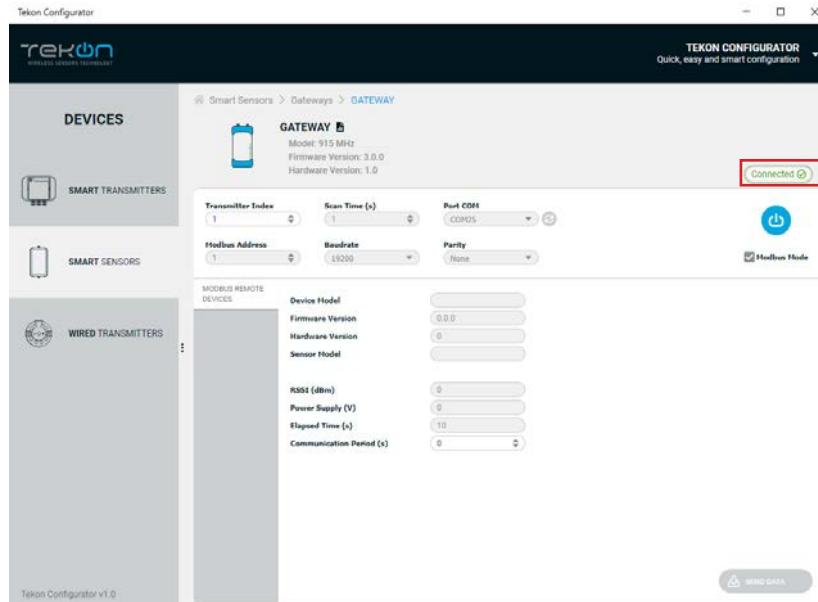

The messages *Connected to Modbus* and *Reading successfully* will appear if the *Serial Port* configuration parameters are correct and the Modbus connection established.

If the blue LED is on and steady and red LED flashes once per second, the *Gateway* is fully operational on the Modbus and wireless interfaces.

step
02

CONNECT AND CONFIGURE THE DUOS WIRELESS TRANSMITTER

step

02

CONNECT AND CONFIGURE THE DUOS WIRELESS TRANSMITTER

The following steps are valid for any *Transmitter* from the *DUOS* system.

The device (previously mentioned as “unknown model”), as well as the firmware and hardware versions, will be detected when the USB is set. The Tekon Configurator software graphical interface is then adjusted to the detected device.

01

Connect probe to the *DUOS Wireless Transmitter*.

The *DUOS Temp Wireless Transmitter* is the device chosen for this guide.



NOTE:

Although the transmitters are physically equal, probe compatibility is different. This means that the *DUOS TEMP Wireless Transmitter* is only compatible with temperature probes (models: Plug and Play probe and Temperature Probe), whereas the *DUOS Hygrotemp Wireless Transmitter* is only compatible with temperature and humidity probes (models: TK07-PFT5 and TK07-MFT9-HC01).

02

Open *Tekon Configurator Software*¹



¹ Tekon Configurator software is free of charge and available at www.tekonelectronics.com

step

02

CONNECT AND CONFIGURE THE DUOS WIRELESS TRANSMITTER

Open the DUOS Transmitter device page.

You can enter the device's page in the following ways:

1st option: Click on **"SMART SENSORS"** in the left menu and then click on the DUOS Temp device.

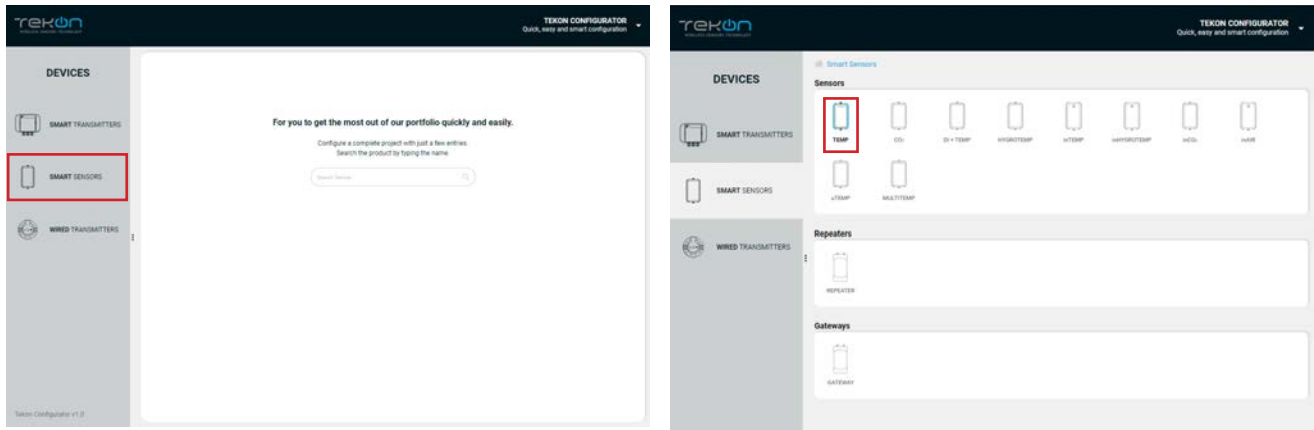

2nd option: Type the name of the device in the **"Search Device"** field on the home page and select.

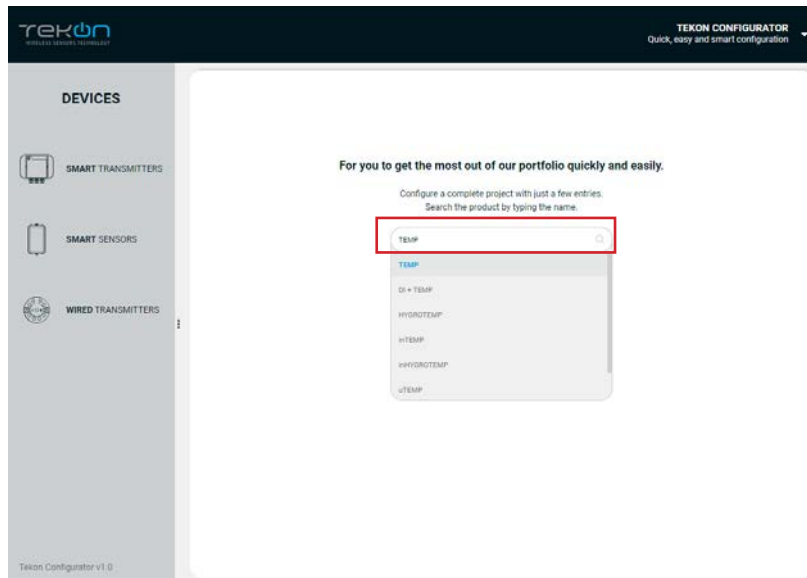

step

02

CONNECT AND CONFIGURE THE DUOS WIRELESS TRANSMITTER

03

Connect the *DUOS TRANSMITTER SARC* cable to the computer and then to the transmitter.

After cable connection, all LEDs stay active during 10 seconds.

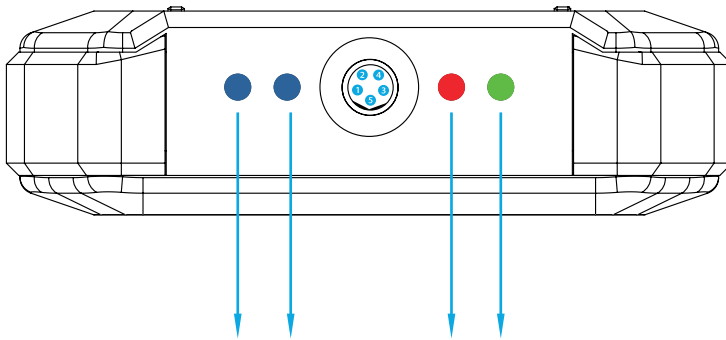

LED switched on and steady

04

Load the "Port COM" corresponding to the DUOS Wireless Gateway.

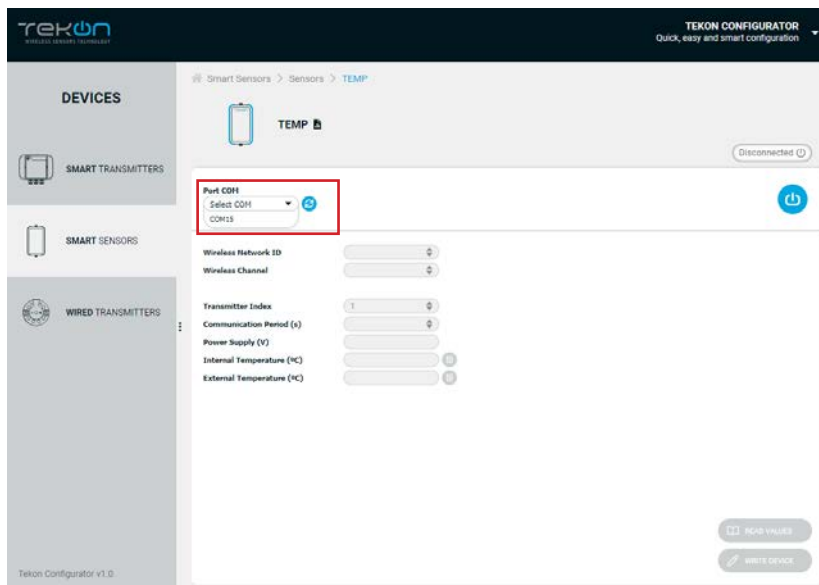

NOTE:

If the USB cable has already been connected before opening the device page, "Port COM" will appear in the list, otherwise you need to click on the "🔌" button.

step

02

CONNECT AND CONFIGURE THE DUOS WIRELESS TRANSMITTER

05

Select corresponding *Port name*².

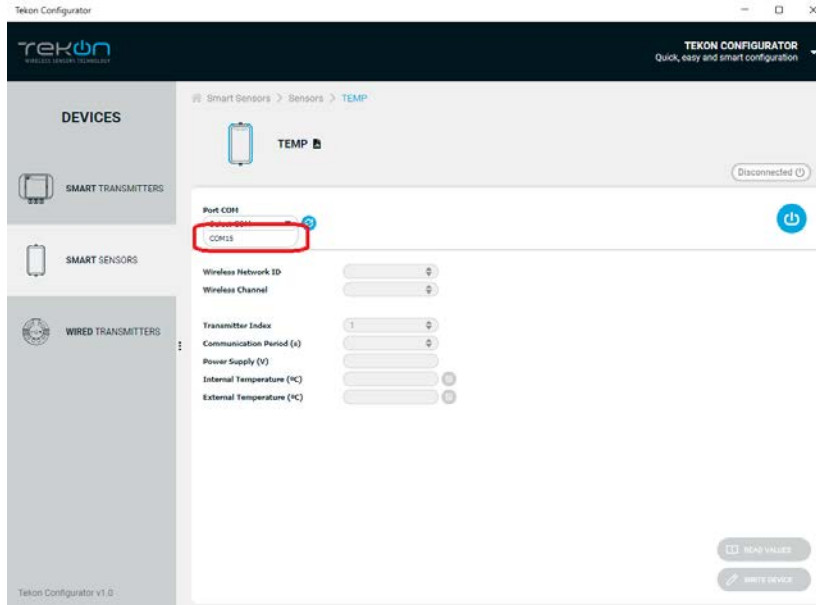

06

Remove the cable from the *Transmitter* side and reinsert it. This will access the device's configuration input window during 10 seconds.



² You can check device's serial port name in "Device Manager" on Microsoft® Windows® operating system.

step
02

CONNECT AND CONFIGURE THE DUOS WIRELESS TRANSMITTER

07

Click on *Connect* () button.

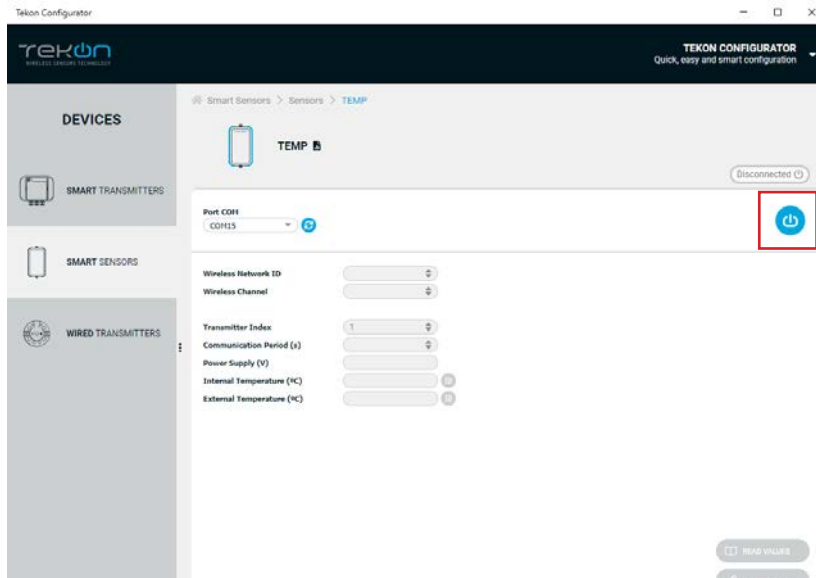

The software will connect to the device.

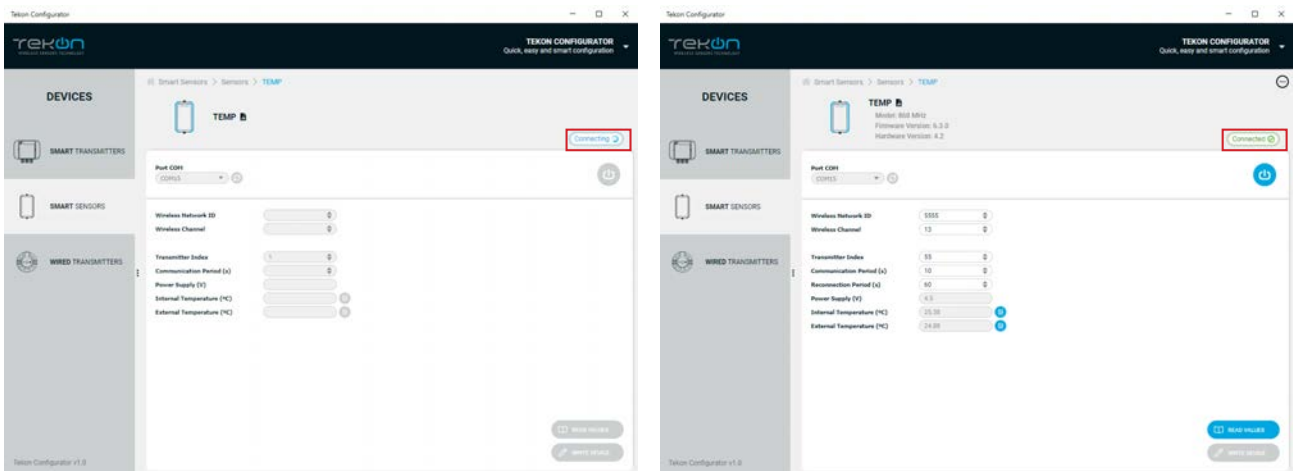

NOTE:



If the software is unable to connect to the device, the Connection Failed status is displayed. If it hasn't connected, go back to the previous steps and check the port COM. When the software connects to the device, the "Connected" message will be displayed, and the gateway will give feedback via the LEDs.

step

02

CONNECT AND CONFIGURE THE DUOS WIRELESS TRANSMITTER

The device's identification data is now available in the software window.
In this guide, the *DUOS TEMP Wireless Transmitter* has been considered.

Click on *Connect* () button to enter configuration mode. These configurations are read automatically.

In configuration mode, the *Transmitter* activates 4 LEDs: 2 blue LEDs flash and the red and green LEDs remain active and steady.

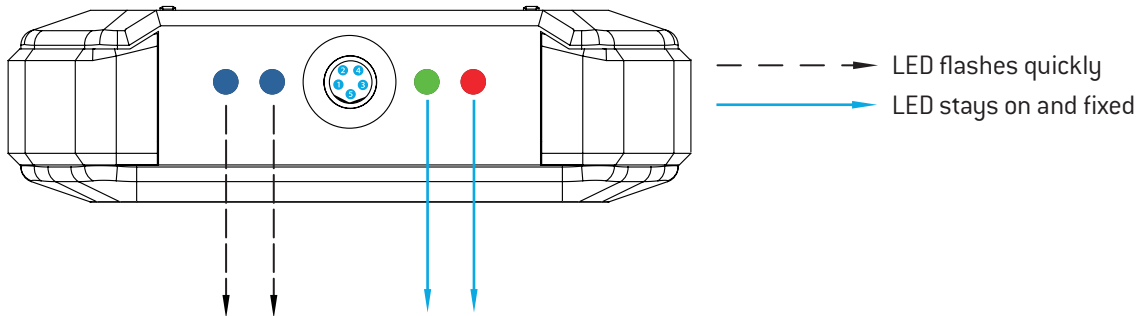

NOTE:

After reinserting the cable, you have 10 seconds to enter configuration mode by clicking on the *Connect* () button, while the blue LEDs flash slowly.
When the 10 seconds have been exceeded, the blue LEDs are steady and it is no longer possible to enter configuration mode.

08

Configure the *Wireless Network ID* and the *Wireless Channel* previously obtained from the *Gateway*. The wireless connection between both devices is ensured by the *Wireless Network ID* and the *Wireless Channel* parameters. Ensure that the *Transmitter ID* is unique in the network. Each device must have a different *Transmitter ID*. Change it (if necessary) and take note to view the data later. On this page you can configure the transmitter's communication period, i.e. the time interval between measurements and communication of the values to the gateway. In addition, you can configure the reconnection period which is only triggered when communication between the gateway and the transmitter fails. When communication fails, the transmitter will try to connect to the gateway using the following logic:

- 5 attempts with the communication period set;
- N attempts with the reconnection period until communication is successful.

The default reconnection period is 30 minutes. Please note that short reconnection periods (< 30 minutes) will impact the transmitter's autonomy if communication takes a long time to be re-established.

step

02

CONNECT AND CONFIGURE THE DUOS WIRELESS TRANSMITTER

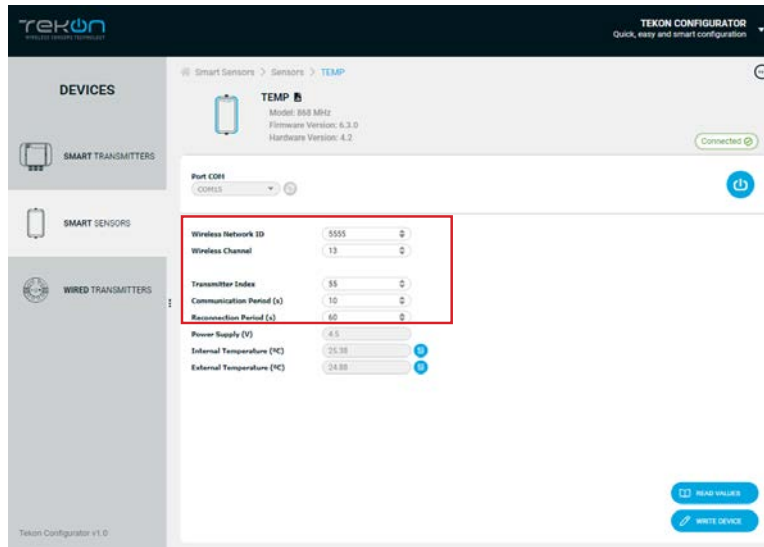

You can change the editable parameters. To save your changes, click on **WRITE DEVICE**. If the changes have been written to the device, the symbol [✓] will appear. If not, the symbol [✗] will appear: try again and check that the device is connected correctly.

09

Click on the *Disconnect* button.

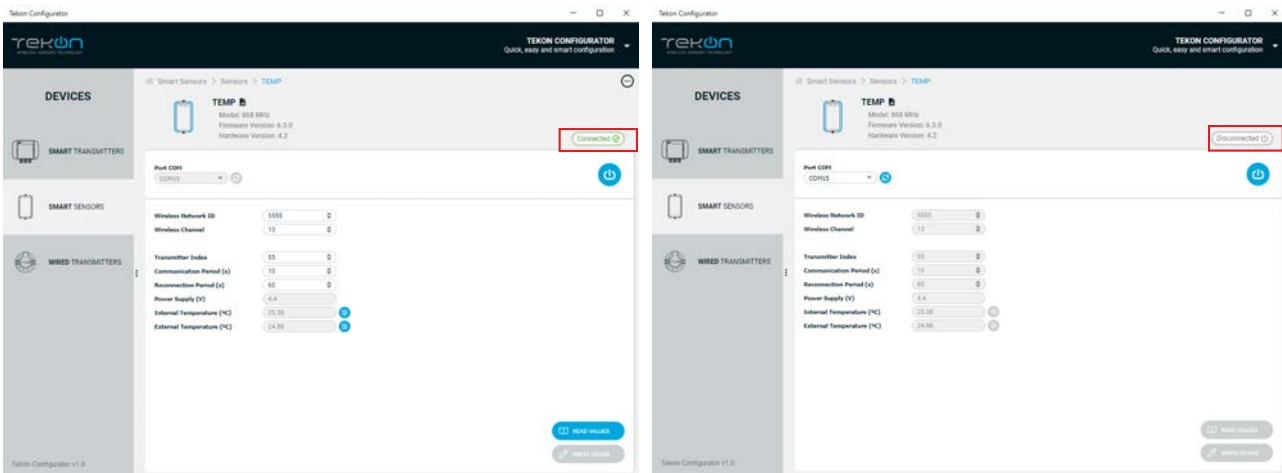

The “Connected” status changes to “*Disconnected*”.

step

02

CONNECT AND CONFIGURE THE DUOS WIRELESS TRANSMITTER

After this procedure:

- The *Transmitter* awaits connection to the *Gateway*, when only the red LED flashes;

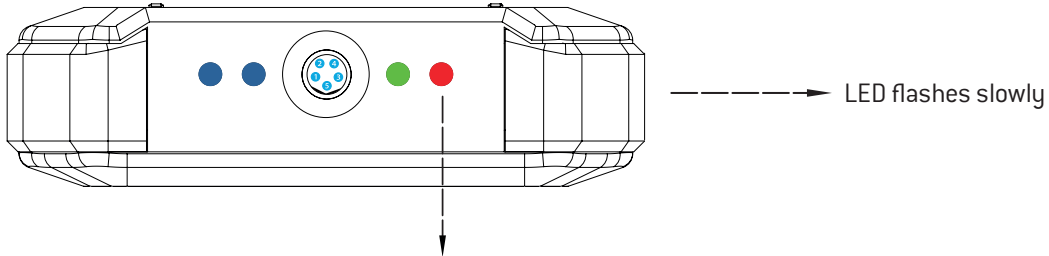

- The *Transmitter* is connected via wireless and its data is available in the *Gateway*, when the red and green LEDs flash.

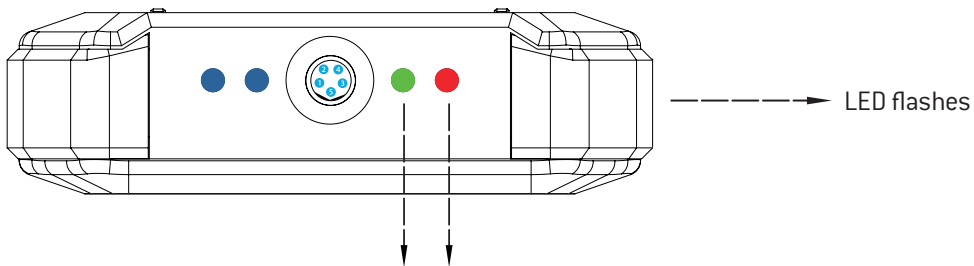

NOTE:

If the green LED does not flash, communication has not been established. Make sure that the devices are at a distance of at least 3 meters, or remove the antenna from the gateway (in case both devices are near each other).

The *Transmitter LEDs* remain active during 1 minute. After this period, all LEDs shut down in order to optimise battery life.

To reset the transmitter, the batteries should be removed, during - at least - 50 seconds (in sleep mode) or instead, as the transmitter has a magnetic switch, a magnet can be used to reset it by passing the magnet close to the transmitter's front side in the blue LED's area.

step
03

**CHECK WIRELESS COMMUNICATION BETWEEN THE DUOS
TRANSMITTER AND THE GATEWAY**

step

03

CHECK WIRELESS COMMUNICATION BETWEEN THE DUOS TRANSMITTER AND THE GATEWAY

01

Place the two windows of Tekon Configurator software devices' side by side, in order to analyse communication between both devices.

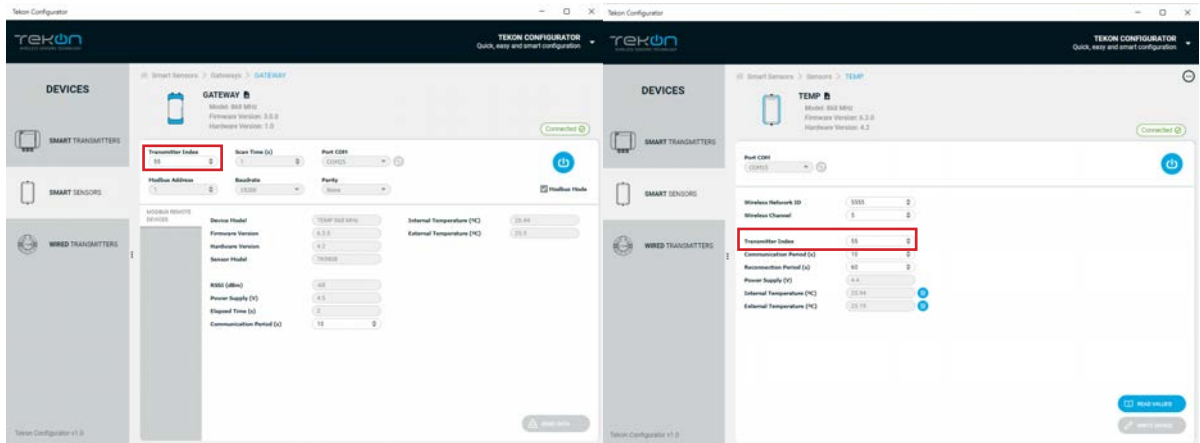

02

Select the configured *Transmitter ID* in the *Gateway* window. After this, it is possible to access the address window of the *Transmitter* in analysis.

The communication between devices is successful when the *Communication Period* field is in compliance with its duration cycle. Therefore, as soon as the cycle duration has finished, it will turn back to 0.

Communication does not occur if the *Elapsed Time* field presents a higher value than the *Communication Period* field.

In the following example, it was established that the temperature monitoring cycle (or *Communication Period*) is 10 seconds. Therefore, the *Elapsed Time* field will turn back to 0 as soon as it reaches 10 seconds and the analysed parameters (in this case, the temperature) will be updated in accordance with ambient conditions.

You can define the communication period of the *Transmitter* in the write field by clicking on the *register* () button.

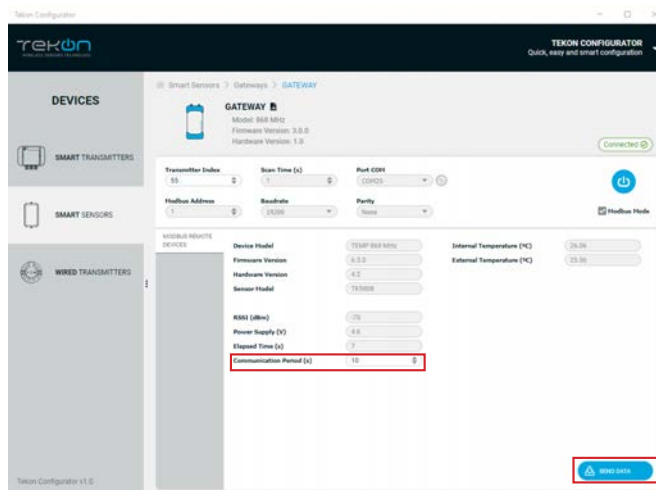

step
04

CONNECT AND CONFIGURE THE DUOS WIRELESS REPEATER

step

04

CONNECT AND CONFIGURE THE DUOS WIRELESS REPEATER

01

Connect the antenna to the *Repeater*.



02

Connect the *DUOS RS485-USB* cable to the computer and then to *Repeater*.



Check the device connection through the LEDs indication.

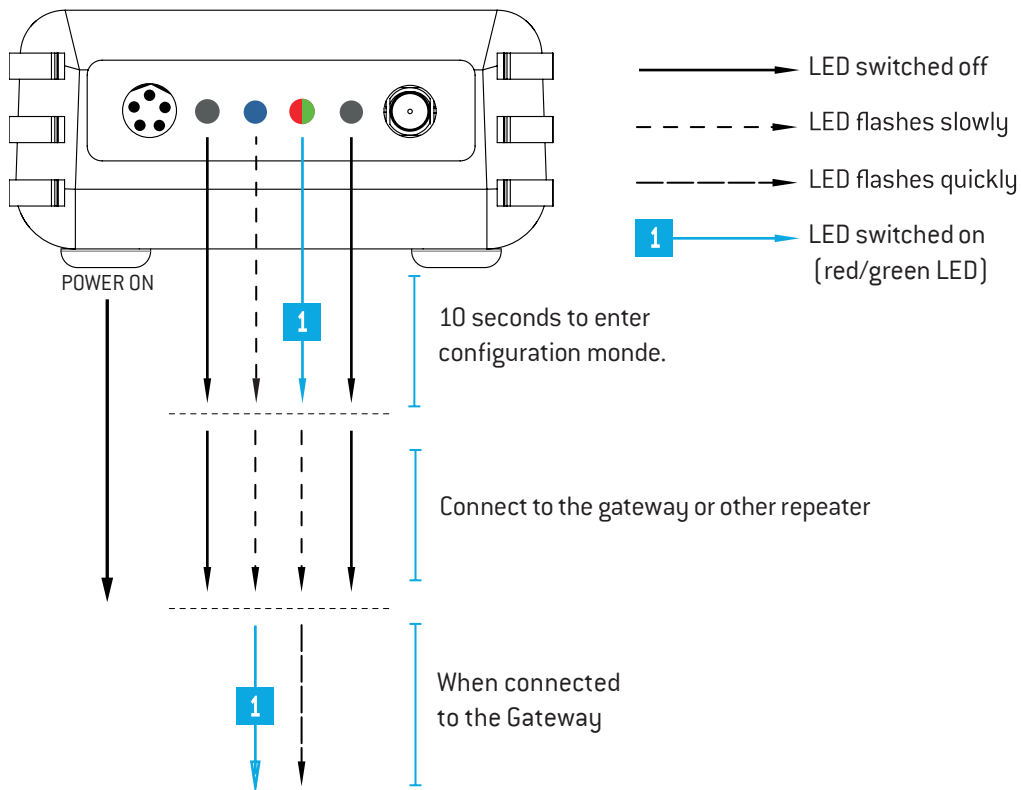

step

04

CONNECT AND CONFIGURE THE DUOS WIRELESS REPEATER

03

Open *Tekon Configurator Software*

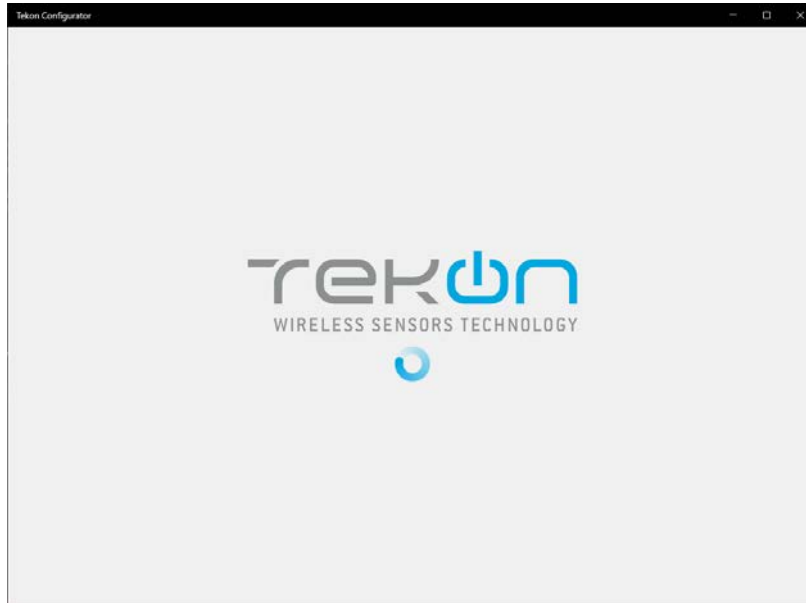

Open the [DUOS Wireless Repeater device page](#).

You can enter the device's page in the following ways:

1st option: Click on **"SMART SENSORS"** in the left menu and then click on the REPEATER device.

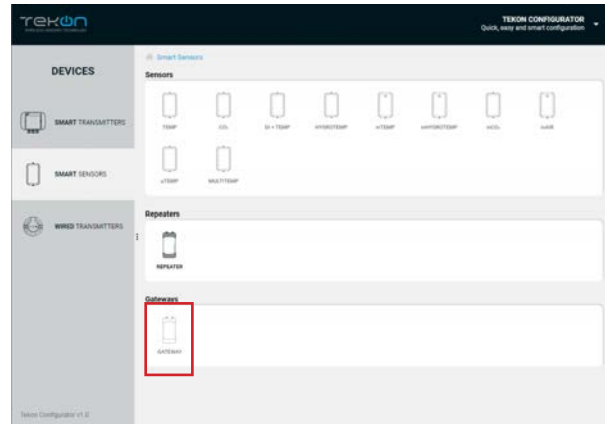
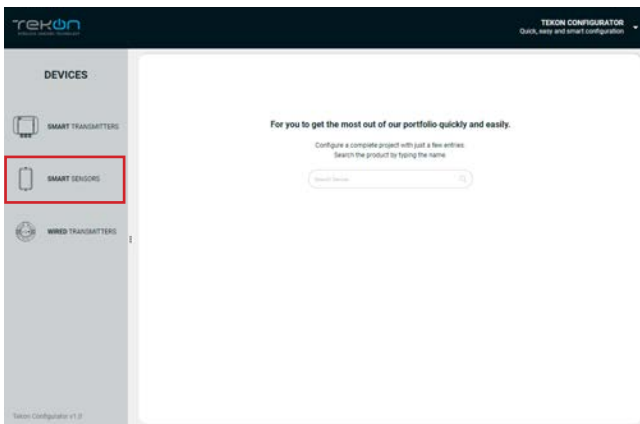

step

04

CONNECT AND CONFIGURE THE DUOS WIRELESS REPEATER

2nd option: Type the name of the device in the “*Search Device*” field on the home page and select.

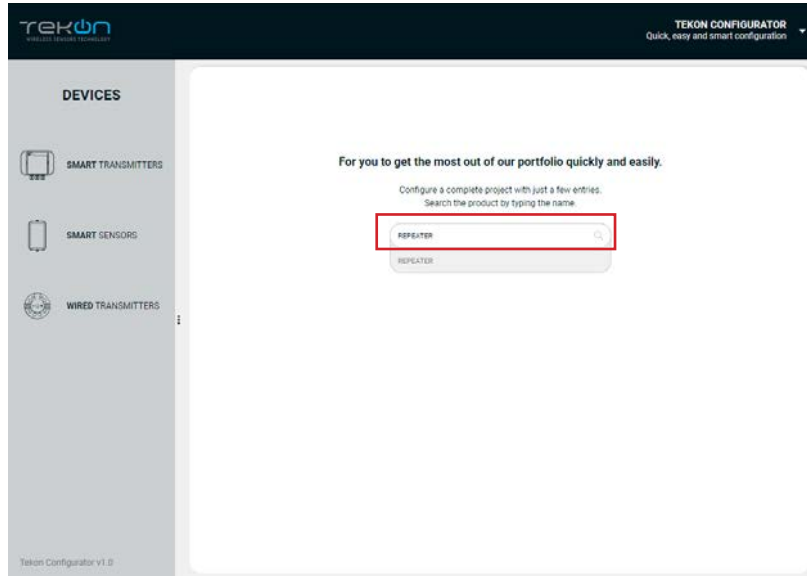

04

Load the “Port COM” corresponding to the DUOS Wireless Repeater.

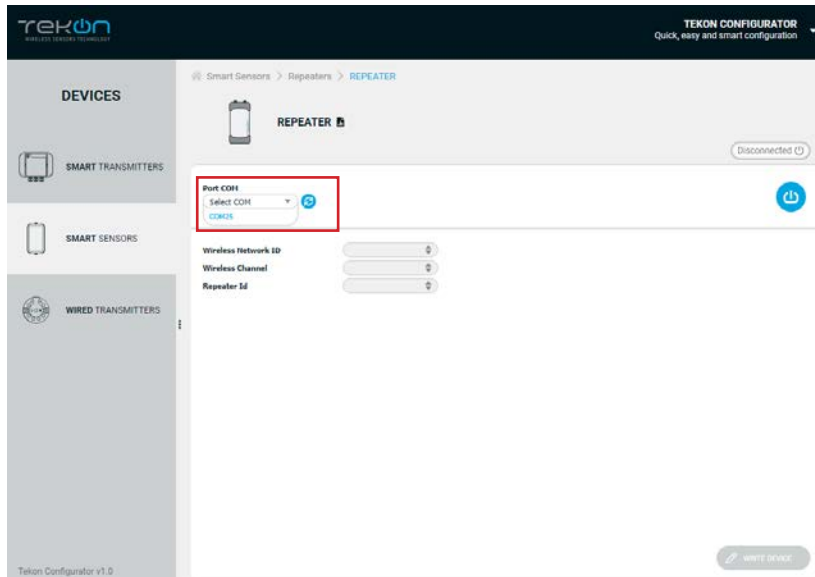

NOTE:



If the USB cable has already been connected before opening the device page, “Port COM” will appear in the list, otherwise you need to click on the “🔌” button.

step

04

CONNECT AND CONFIGURE THE DUOS WIRELESS REPEATER

05

Select corresponding *Port name*².

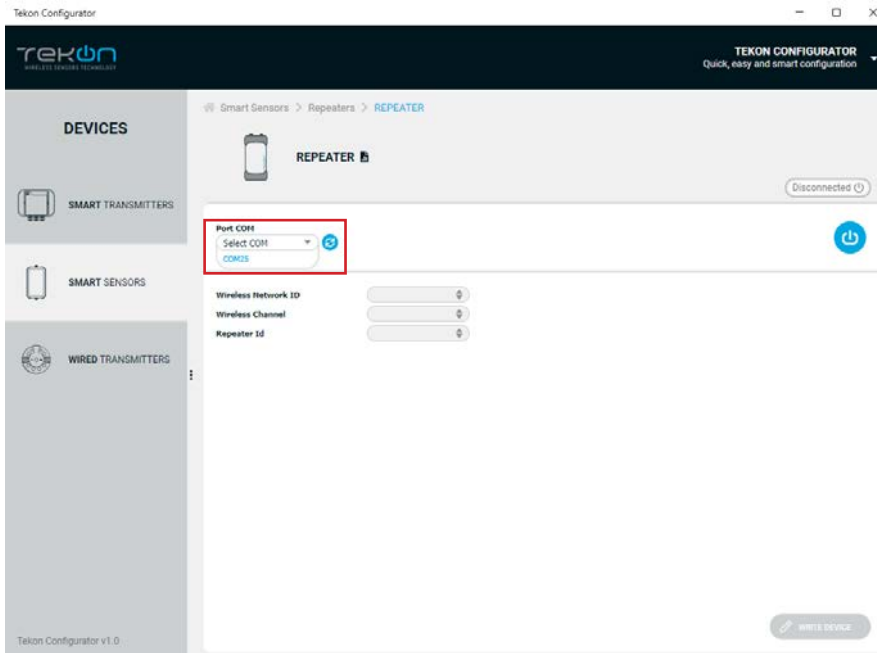

06

Remove the cable from *Repeater* and reinsert it. After reinserting the cable you have 10 seconds to enter configuration mode by clicking on the *Connect* (⚡) button, while the blue LED flashes slowly.



NOTE:

When the 10 seconds have been exceeded, the blue LED remains steady and it is no longer possible to enter *Configuration mode*. In that case, the cable must be removed from Repeater and reinserted.

² You can check device's serial port name in "Device Manager" on Microsoft® Windows® operating system.

step

04

CONNECT AND CONFIGURE THE DUOS WIRELESS REPEATER

07

Click on *Connect* () button.

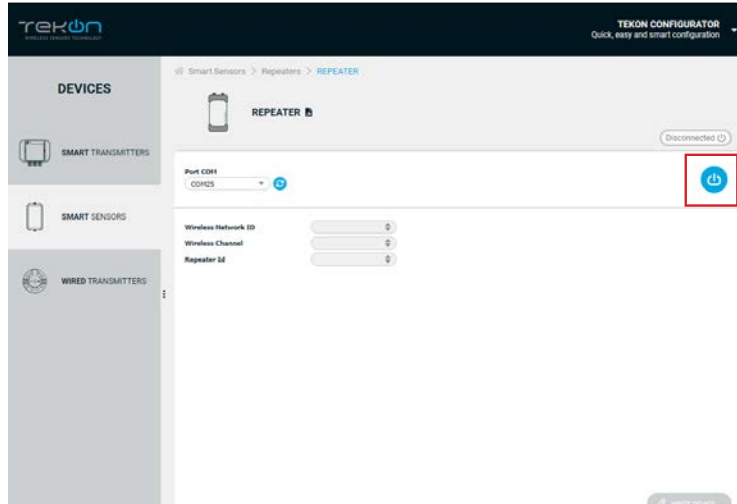

The software will connect to the device.

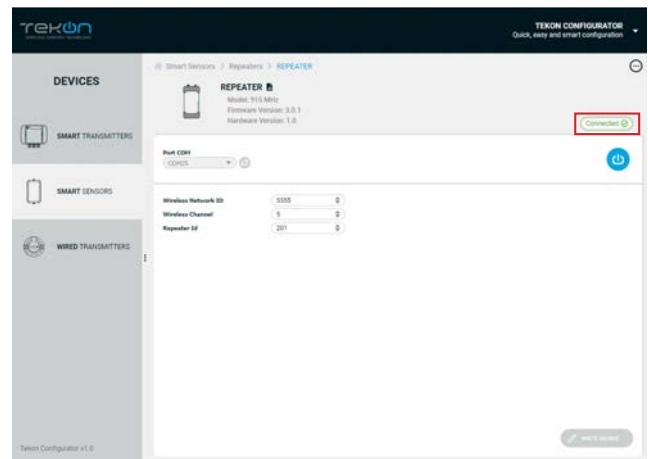
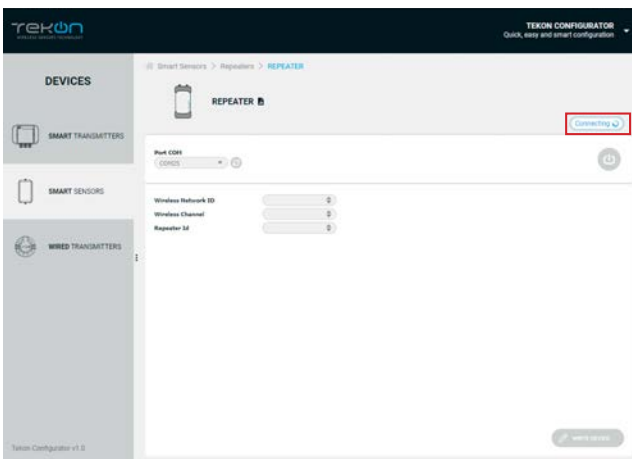





NOTE:

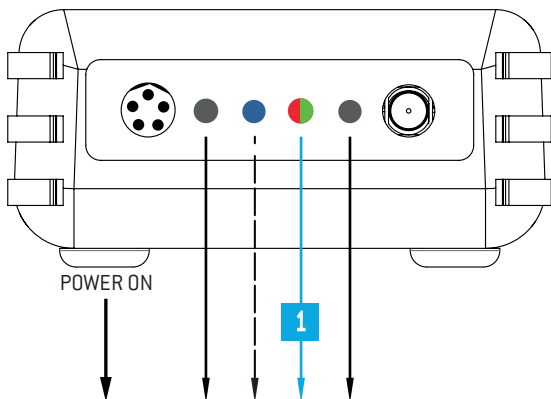

If the software is unable to connect to the device, the **Connection Failed** () status is displayed. If it hasn't connected, go back to the previous steps and check the port COM. When the software connects to the device, the "Connected" message will be displayed, and the gateway will give feedback via the LEDs.



-  LED switched off
-  LED flashes slowly
-  LED flashes quickly
-  LED switched on (red/green LED)

step

04

CONNECT AND CONFIGURE THE DUOS WIRELESS REPEATER

08

Make sure that *Wireless Network ID* and *Wireless Channel* in the *Repeater* window have the same values as the ones that were obtained in the *Gateway* configuration window.

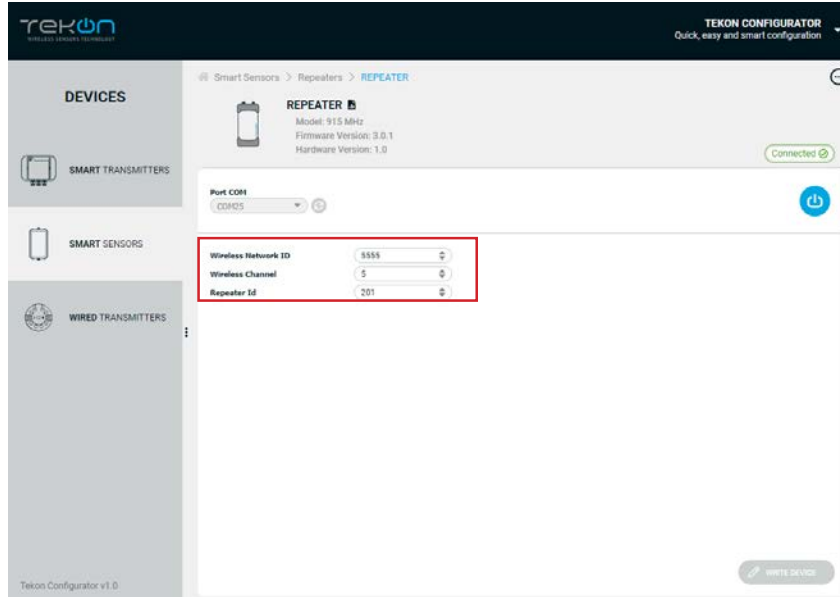

NOTE:

If there is more than one *Repeater* in the network, make sure that the *Repeater ID* is unique in order to avoid network conflict.

09

You can change the editable parameters. To save your changes, click on **WRITE DEVICE**. If the changes have been written to the device, the symbol [✓] will appear.

If not, the symbol [✗] will appear: try again and check that the device is connected correctly.

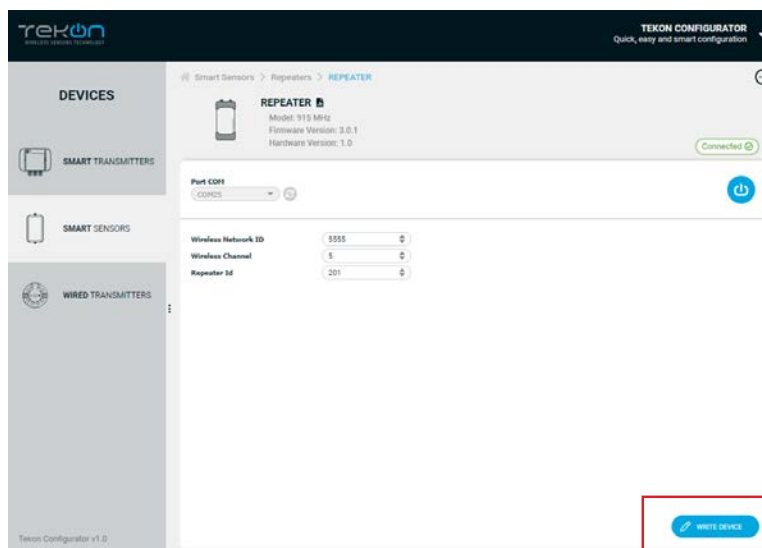

step
04 | CONNECT AND CONFIGURE THE DUOS WIRELESS REPEATER

09

Click on the *Disconnect* button.

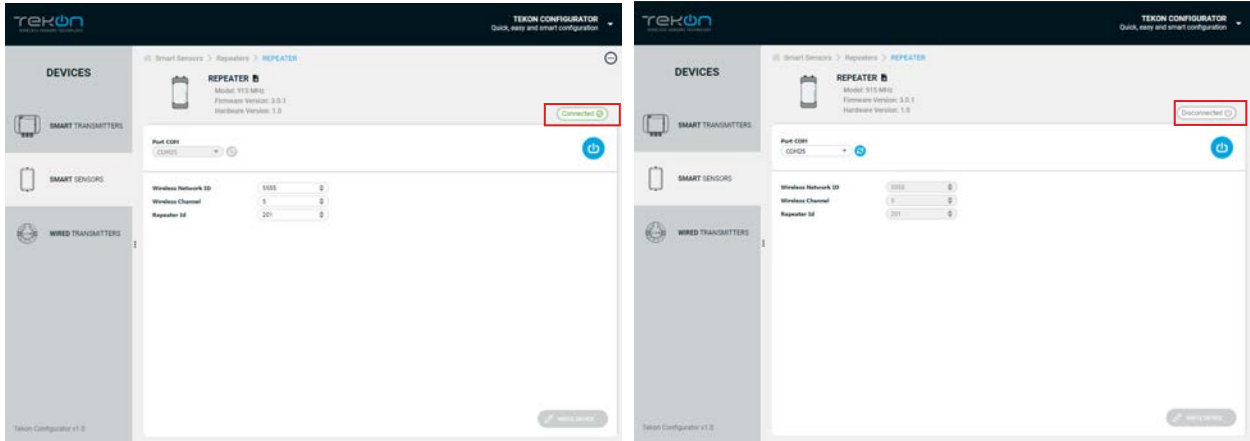

The "Connected" status changes to "Disconnected".



NOTE:

In order to establish communication between the Repeater and the Gateway, make sure that both devices are at a distance of at least 3 meters or remove the antenna from the repeater (in case both devices are near each other). These procedures will guarantee communication quality.

At this moment, it is possible to check if:

- The *Repeater* is trying to connect to the network when the red LED flashes every second.

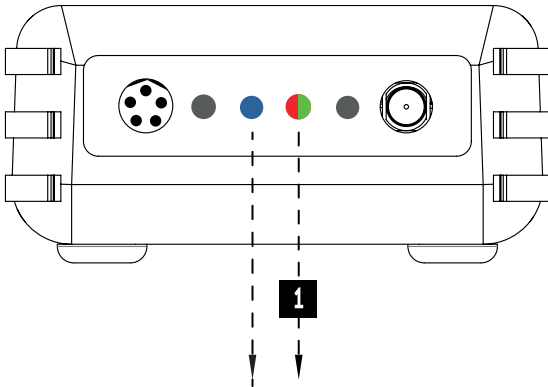

- LED flashes slowly
- 1** --- Red LED flashes until communication can be established

- The *Repeater* is connected to the wireless network when red and green LEDs flash.

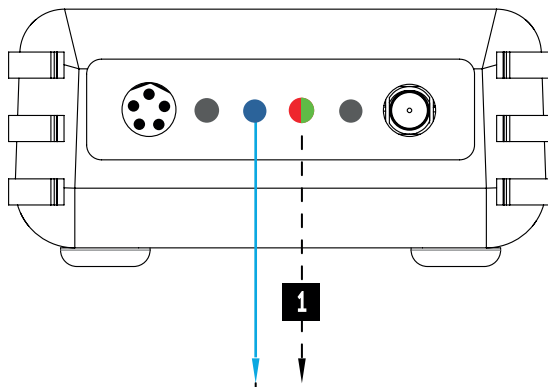

- LED switches on and remains steady
- 1** --- Red/green LED flashes as soon as connection between the devices has been established.

step
05

CONNECT THE DUOS WIRELESS IOT GATEWAY

step

05

CONNECT THE DUOS WIRELESS IoT GATEWAY

01

Change the switch pin to *Normal Mode*.

Plug the ethernet cable that follows with your gateway to the device's input and to your network.



02

Your **DUOS IoT GATEWAY** physical connection should look like this.



WIFI



The access through this interface only allows the configuration and consultation of **DUOS IoT GATEWAY**. Unable to send data to the cloud over this channel.

The **DUOS IoT GATEWAY** appear with an SSID with the following configuration *WGW4IoT-hostname*. By default, the devices follow with the SSID *WGW4IoT-<serialnumber>*

03

Connect to the wifi network that comes from your gateway.

Use the password *bresimar* to login.

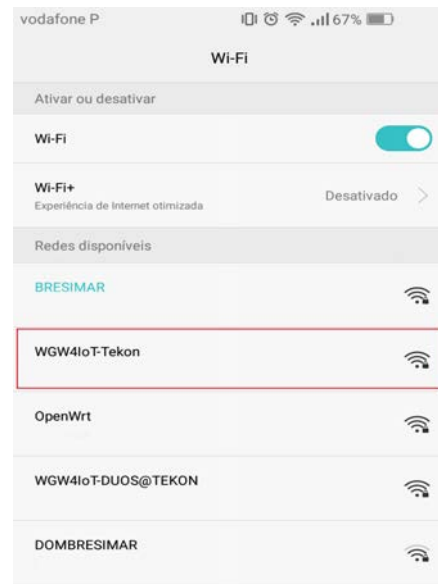

step
05 | CONNECT THE DUOS WIRELESS IoT GATEWAY

DUOS IoT GATEWAY has a fixed IP address assigned to be accessed via mobile phone, tablet or pc (through Wi-Fi). The interface designed to interact with the device can be accessed through its fixed IP [192.168.128.1] or its SSID address [http://Tekon]. The factory-defined and configurable access data are:

- **Login:** admin
- **Password:** admin



NOTE:

This password and username must be changed to improve the security level.



NOTE:

After a power-on cycle, the first access to the gateway may have a long time waiting time and should not be confused with a lack of response.



NOTE:

SSID address access is only possible until it is changed. After the change, you must access by the user-defined SSID.

04

Check your network credentials. Click on [Settings](#) >> [IP Network](#) tab.

By default, your gateway has a static ethernet IP address for the network [192.168.100.1]. You can choose to keep this IP address or activate the DHCP feature to be assigned a dynamic IP address by the network.

The screenshot displays the Tekon IoT Gateway web interface. At the top, the 'SETTINGS' tab is highlighted, and the 'Network' sub-tab is selected. Below the navigation bar, the 'IP Network Table' is shown with a search field and a 'Show 10 entries' dropdown. The table lists three interfaces: 'eth0' with IP '192.168.100.1', 'lo' with IP '127.0.0.1', and 'ra0' with IP '192.168.128.1'. Below the table, there are sections for 'NTP' configuration (with 'NTP Peer' set to 'pt.pool.ntp.org') and 'Proxy Configuration' (with fields for 'HTTP Proxy' and 'HTTPS Proxy').

step
05 | CONNECT THE DUOS WIRELESS IoT GATEWAY

05 To enable the option to get an dynamic IP address assigned by your network, click on *Manage* button.

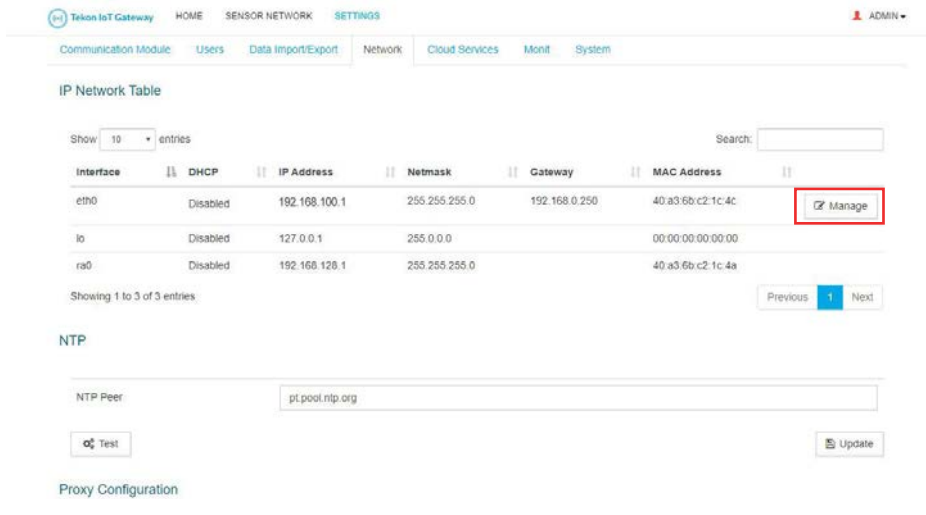

06 A pop-up window will show up. Click on the validation box, next to the *DHCP* label to enable the option and click on the *Update* button to save the changes. You will be redirected to the previous page.

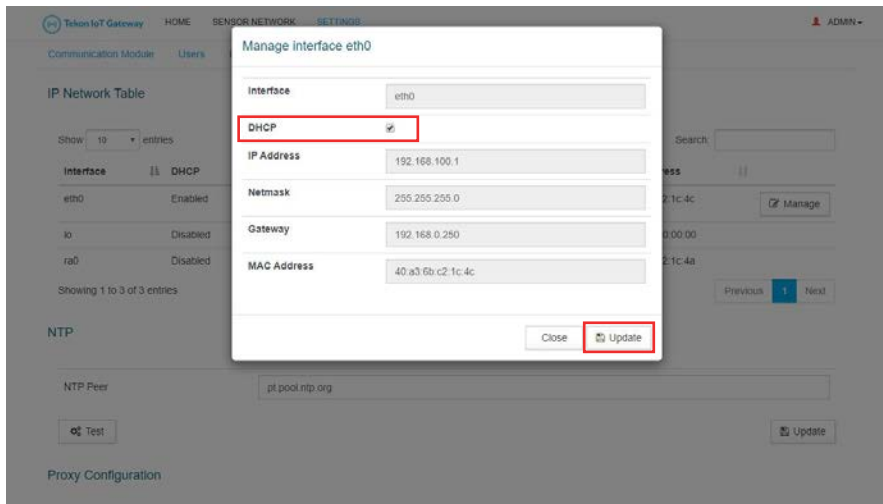

Write down the IP address of your device's ethernet port. It will be needed later.

step
05 | CONNECT THE DUOS WIRELESS IoT GATEWAY

CONFIGURE A PROXY SERVER (OPTIONAL)

07

You can configure a proxy server to your gateway. Go to the [Settings](#) >> [Network](#) >> [Proxy Configuration](#). Complete the [HTTP Proxy](#) and [HTTPS Proxy](#) fields with the [correct address](#) of your proxy server.

Click on the [Update](#) button to save the changes.

Interface	DHCP	IP Address	Netmask	Gateway	MAC Address	
eth0	Disabled	192.168.100.1	255.255.255.0	192.168.0.250	40:a3:6b:c2:1c:4c	<input type="checkbox"/> Manage
lo	Disabled	127.0.0.1	255.0.0.0		00:00:00:00:00:00	
ra0	Disabled	192.168.128.1	255.255.255.0		40:a3:6b:c2:1c:4a	

Showing 1 to 3 of 3 entries Previous **1** Next

NTP

NTP Peer:

Proxy Configuration

HTTP Proxy:

HTTPS Proxy:



NOTE:

The proxy address must consider the full path configuration like in the example: 'http://my.proxy.com:9000' or 'https://my.secure.proxy.com:9000'

step

05

CONNECT THE DUOS WIRELESS IoT GATEWAY

ACCESS TO DUOS GATEWAY IOT THROUGH ETHERNET

08

The connection to **DUOS IoT GATEWAY** through Ethernet is made using your web browser. You can access by the hostname (`http://<hostname>`) or via IP address (`http://<192.168.100.1>`).

The default login credentials are:

- **Login:** admin
- **Password:** admin

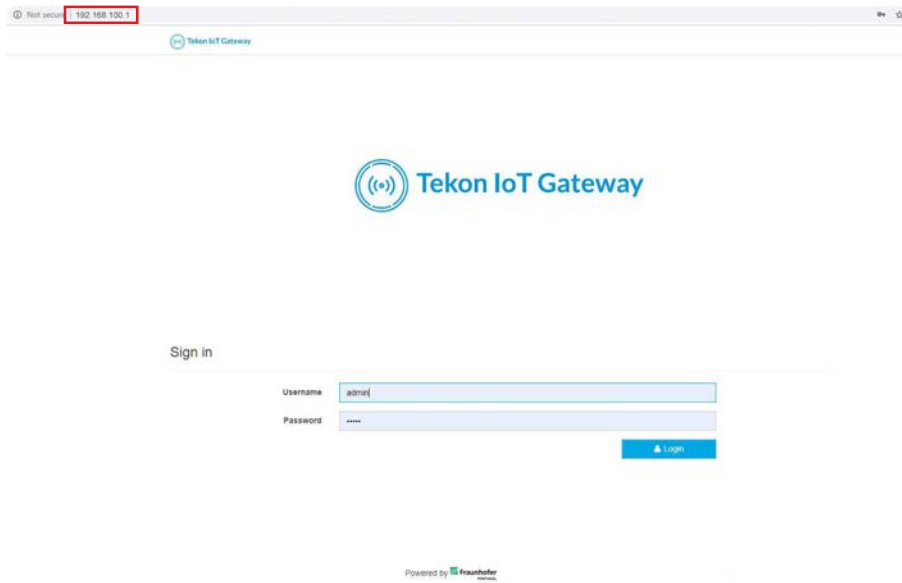

NOTE:

DUOS IoT GATEWAY access credentials displayed by default can be edited in *Settings* » *Users* menu.

step
05 | CONNECT THE DUOS WIRELESS IoT GATEWAY

TRANSMITTER ACTIVATION

09

At login, the graphical interface displays the transmitters that are connected to the network. The first presentation of the devices connected to the network is through a vertical listing (1). To get an overview of your system, at the bottom of the main page, you will find information about the activity and links established (2).

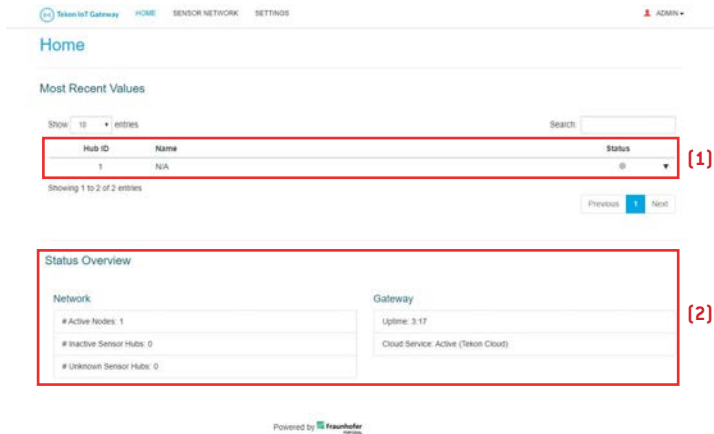

The transmitters are listed in ascending numerical order. By default, the name appears with “N/A” until it is edited and reset. The *Hub ID* field match to the *Transmitter ID* field defined in *Tekon Configurator* over the transmitter configuration.

10

Click on the *Hub ID* field of the transmitter to activate. You will be redirected to the selected transmitter page, select the *Properties* tab (1), in the *Status* property, choose the *Active* state (2) and click on the *Update* button (3) to save the change.

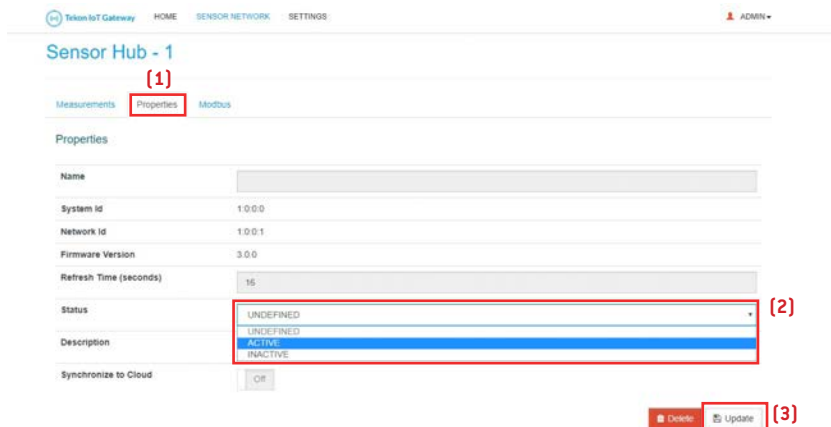

step
05 | CONNECT THE DUOS WIRELESS IoT GATEWAY



The transmitter is activated.
Transmitter information available for all the interfaces.



If you would like to send data from this transmitter to Tekon IoT Platform, set the *Synchronize to Cloud* field to *On* mode and save the changes. We will return to this subject shortly.

11

In the "Properties" tab, fill in the fields:

- **"Name"** and **"Description"** according to your preference;
- **"Refresh Time"** according to the intended transmitter communication period;

Save the changes in the *Update* button.

Tekon IoT Gateway HOME SENSOR NETWORK SETTINGS ADMIN

Sensor Hub - 1

Measurements Properties Modbus

Properties

Name	DUOS CO2 - Comercial Warehouse
System Id	1.0.0.0
Network Id	1.0.0.1
Firmware Version	3.0.0
Refresh Time (seconds)	16
Status	ACTIVE
Description	Black DUOS CO2 transmitter in comercial warehouse

Synchronize to Cloud Off

Delete Update



The transmitter is configured.

step
05 | CONNECT THE DUOS WIRELESS IoT GATEWAY

CONNECTION TO TEKON IOT PLATFORM

12

In the DUOS IoT GATEWAY page, go to [Settings](#) >> [Cloud Services](#).

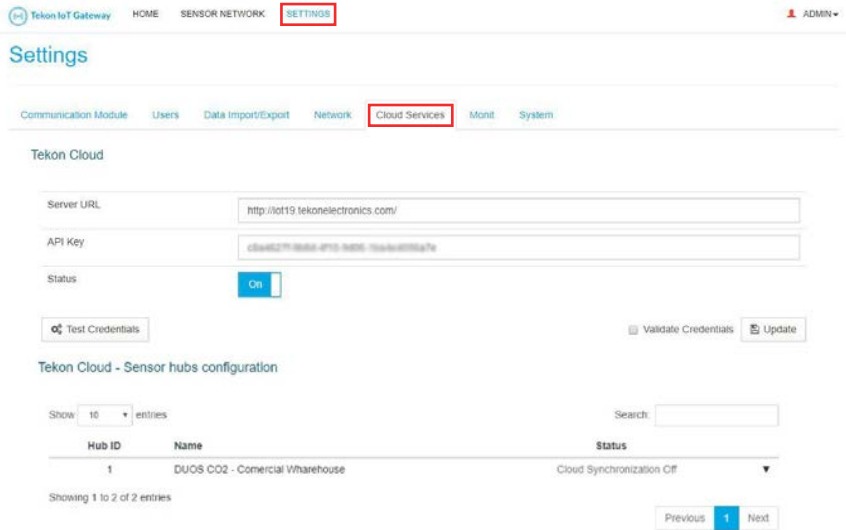

13

In a new browser page, access your Tekon IoT Platform and go to [Settings](#) >> [Administration](#).

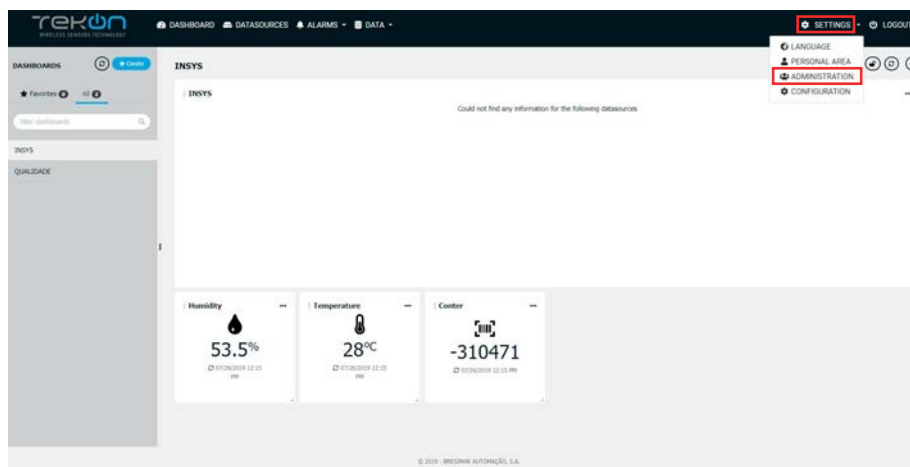

step
05 | CONNECT THE DUOS WIRELESS IoT GATEWAY

14 Click on the view option to see the *gateway* user data and copy the API key.

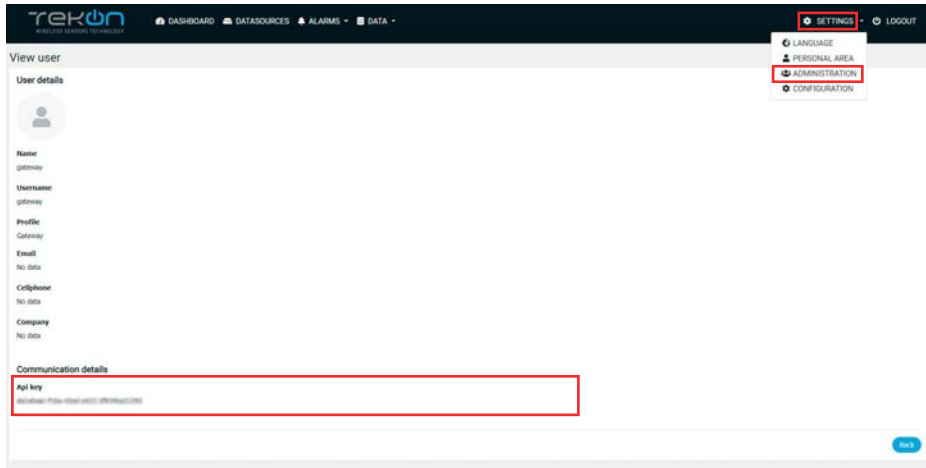

15 In the **DUOS IoT GATEWAY** page, fill in the fields:
 - **“Server URL”** with your Tekon IoT Platform address;
 - **“API Key”** with the Api key previously copied;

Change the *Status* field value to *On*.

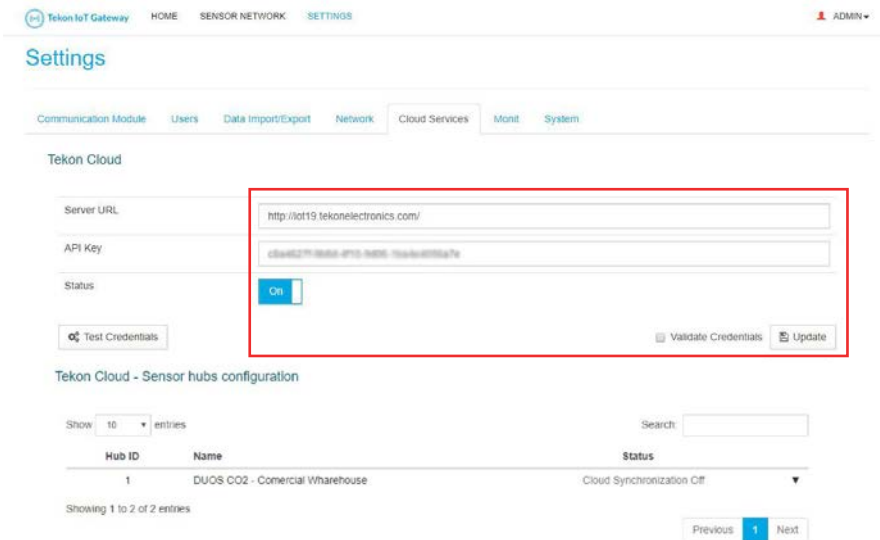

step
05 | CONNECT THE DUOS WIRELESS IoT GATEWAY

16

You can test the credentials declared. Click on *Test Credentials* button to test the credentials authenticity. If the credentials are authentic, a success message will show next to the button.

You can validate the credentials. This step will ensure data the credentials entered are authentic. Click on the *Validate Credentials* checkbox.

Click on *Update* button to save the changes. If *Validate Credentials* is checked, the configured data is stored only if valid. Pay attention to the received message.

The screenshot shows the 'Settings' page for the Tekon IoT Gateway. The 'Tekon Cloud' section contains the following fields and controls:

- Server URL:
- API Key:
- Status:
- Test Credentials: (highlighted with a red box)
- Authentication Ok: (highlighted with a red box)
- Validate Credentials: (highlighted with a red box)
- Update: (highlighted with a red box)

Below this section is the 'Tekon Cloud - Sensor hubs configuration' table:

Hub ID	Name	Status
1	DUOS CO2 - Comercial Warehouse	Cloud Synchronization Off

Showing 1 to 2 of 2 entries. Navigation buttons: Previous, 1, Next.



Your DUOS GATEWAY IoT is now connected to your Tekon IoT Platform instance.

step
05 | CONNECT THE DUOS WIRELESS IoT GATEWAY

ATTACH TRANSMITTER DATA TO TEKON IOT PLATFORM

18

Access to your Tekon IoT Platform, click at the *Datasources* menu and the button (✎) to edit the datasource where you want to send the transmitter data.

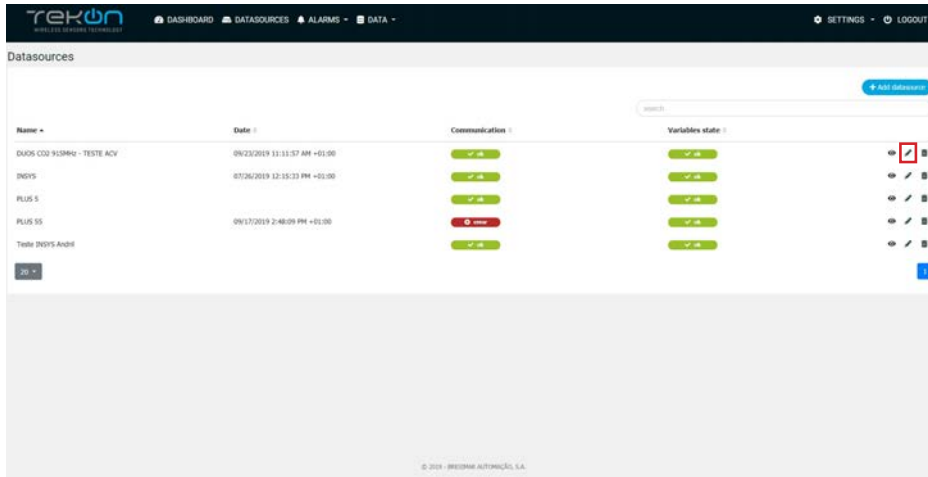

19

Copy the API key from the datasource and go back to your DUOS IoT GATEWAY page. On the page, select the transmitter you want to match, fill in the *API Key* field with the copied value.

You can test and validate the credentials, as explained in the step 16.

Click on *Update* button to save the changes.

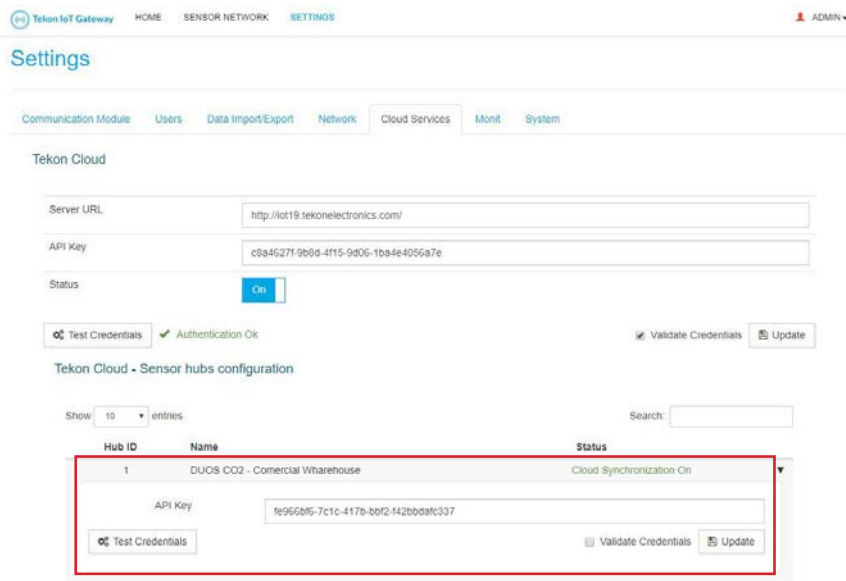

step
05 | CONNECT THE DUOS WIRELESS IoT GATEWAY



NOTE:

The message “Cloud Synchronization On” will only be visible if you have activated the option “Synchronize to Cloud” in the “TRANSMITTER ACTIVATION” step to activate your transmitter. If you did not perform the validation, the message “Cloud Synchronization Off” will be displayed in the “Status” field.



Your transmitter is now connected to your Tekon IoT Platform.



NOTE:

Perform a reboot in the gateway. Remove the *DUOS RS485-USB* cable on the gateway port and reconnect it.

VERIFY COMMUNICATION WITH TEKON IOT PLATFORM

20

To verify if the information acquired by the transmitter is effectively reaching your [Tekon IoT Platform](#), click on the [Datasources](#) menu and check the date of the latest communication between the platform and the transmitter. This log will tell you if the communication process is on or not.

Name	Date	Communication	Variables state
DUOS CO2 935M4 - TESTE ACV	09/23/2019 11:33:57 AM +01:00	OK	OK
INDYS	07/26/2019 12:55:23 PM +01:00	OK	OK
PLUS S		OK	OK
PLUS S5	09/17/2019 2:48:09 PM +01:00	ERROR	OK
Teste INDYS Andri		OK	OK

step
05 | CONNECT THE DUOS WIRELESS IoT GATEWAY

DATA COMMUNICATION OVER MODBUS TCP/IP

21

You can pre-check the **DUOS IoT GATEWAY** graphical interface of Modbus TCP/IP communication. In each transmitter you can analyze different common parameters in modbus communications.

Click on the transmitter / hub you want to analyze and select the **Modbus** tab.

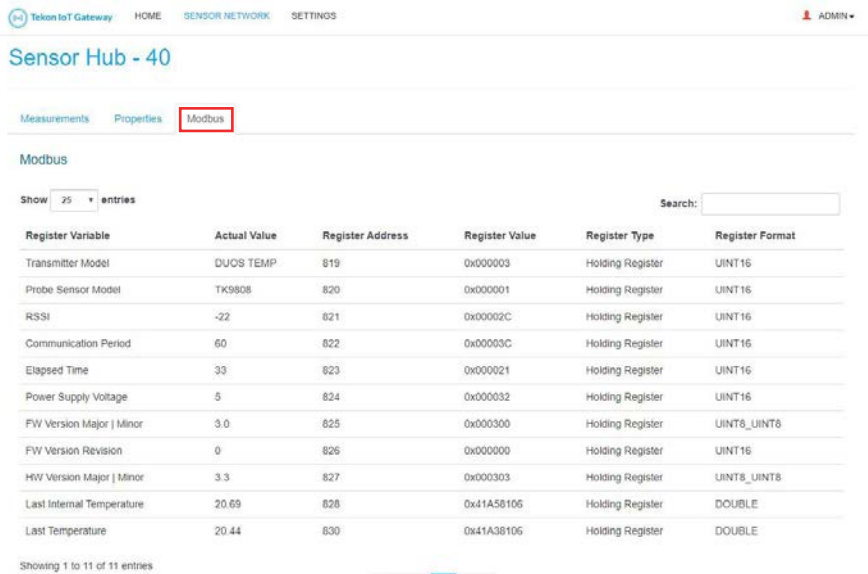

22

In this page, you have the selected transmitter modbus scheme.

- (1): variable names;
- (2): current value recorded;
- (3): modbus address;
- (4): register value;
- (5): register type;
- (6): register data type;

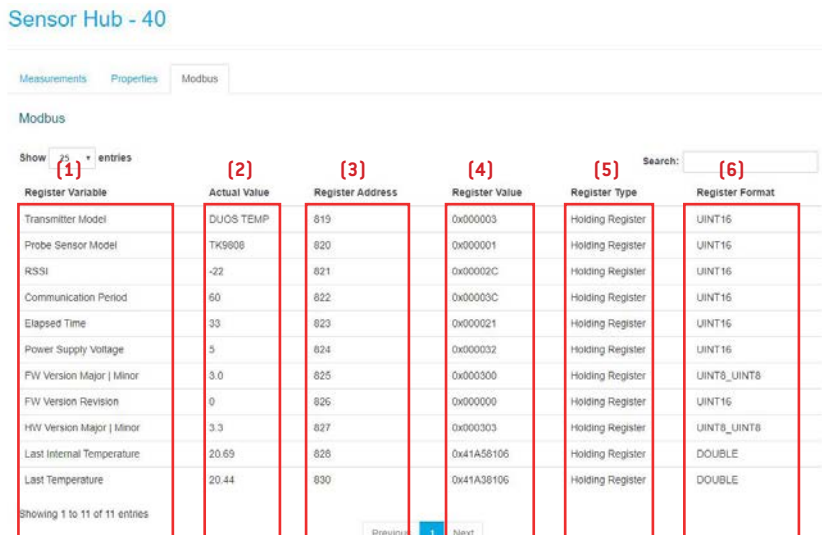

step
05 | CONNECT THE DUOS WIRELESS IoT GATEWAY



NOTE:

In this example we used the transmitter / hub 1. The first modbus address of its variables starts at 0. To find the modbus address calculation formula defined for DUOS IoT GATEWAY, please refer the datasheet on Tekon Electronics website.



To access to the records via [Modbus TCP/IP](#) in real time, you must use a program developed for this purpose, external to Tekon Electronics.

Configuration of Modbus TCP/IP:

- [DUOS IoT GATEWAY](#) IP;
- [Port](#): 1502;

TEKON ELECTRONICS
a brand of Bresimar Automação S.A.

Quinta do Simão
3800-230 Aveiro
PORTUGAL

P.: +351 234 303 320
M.: +351 933 033 250
E.: sales@tekonelectronics.com

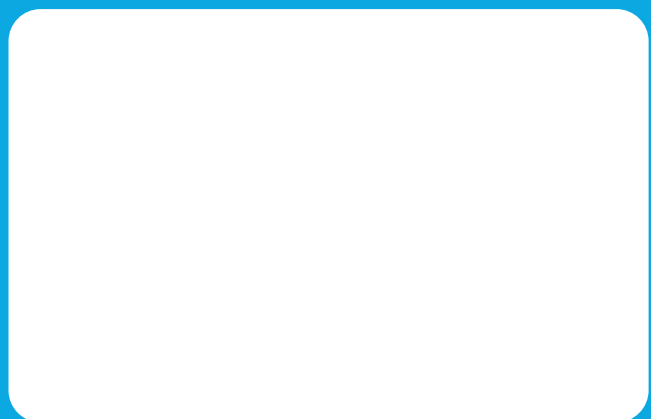

Cofinanciado por:



UNIÃO EUROPEIA
Fundo Europeu
de Desenvolvimento Regional