



DUOS WIRELESS SYSTEM INSTALLATION GUIDE

IG_DUOS_E010

DUOS WIRELESS SYSTEM

INSTALLATION GUIDE

Table of contents

step
01 **CONNECT AND CONFIGURE THE DUOS WIRELESS GATEWAY**
Pages 4 to 11

step
02 **CONNECT AND CONFIGURE THE DUOS WIRELESS TRANSMITTER**
Pages 12 to 17

step
03 **CHECK WIRELESS COMMUNICATION BETWEEN THE DUOS TRANSMITTER AND THE GATEWAY**
Page 18

DUOS WIRELESS SYSTEM

INSTALLATION GUIDE

Table of contents

step
04 **CONNECT AND CONFIGURE THE DUOS WIRELESS REPEATER**
Pages 19 to 25

step
05 **CONNECT THE DUOS WIRELESS IOT GATEWAY**
Pages 26 to 39

LEGEND:



Important information for the setup;



Take note of the information;



Validation of a setting;

step

01

CONNECT AND CONFIGURE THE DUOS WIRELESS GATEWAY



NOTE:

If your device is a DUOS IoT GATEWAY, please consider the information on this page. If your device is a DUOS GATEWAY, please go to the next page to start the equipment setup.

SYSTEM ARCHITECTURE

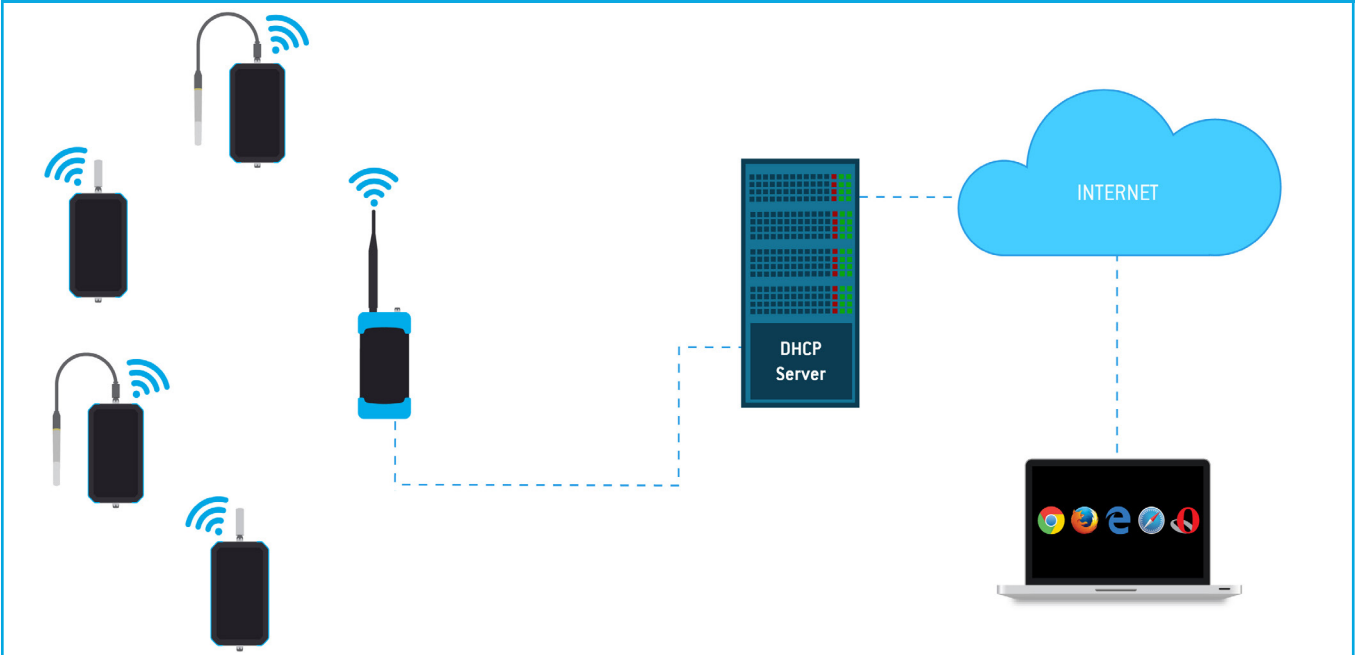

MINIMUM REQUIREMENTS

The right application of DUOS IoT GATEWAY only occurs if all minimum requirements are met by the customer side. The architectural minimum requirements needed to successfully use this device are:

- **Ethernet cable** (included with your DUOS IoT GATEWAY);
- **DHCP server;**
- **Web browser with the latest version;**

You must have a DHCP server in your network. The main purpose of this kind of server is to automatically provide and assign IP addresses and other networks parameters to connected devices.

To begin the configuration of DUOS IoT GATEWAY, the pin of button mode, must be in the *Config Mode* side.

After completing the setup procedures, go to [step 5](#) to begin the connection to the platform.



step

01

CONNECT AND CONFIGURE THE DUOS WIRELESS GATEWAY

TEKON CONFIGURATOR SOFTWARE is only compatible with the Microsoft Windows Operating System.

01

Connect the antenna to the *Gateway*.



02

Connect the *DUOS RS485-USB* cable to the computer and then to the Gateway.



03

Check the device connection through the LED signage.
If the red and blue LEDs are active, both the cable and *Gateway* are working correctly.

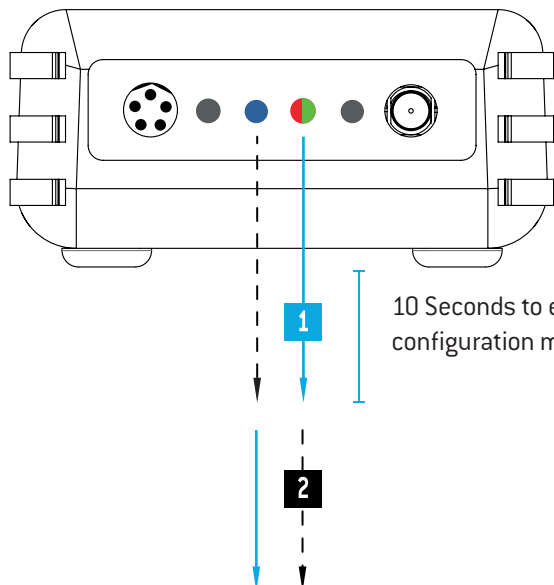

- LED flashes slowly
 - 1** — LED switched on and steady
 - 2** --- Red LED flashes every second whenever it sends beacons to new elements to join the network
- Green LED flashes as soon as the device receives data from other equipment.

step
01

CONNECT AND CONFIGURE THE DUOS WIRELESS GATEWAY

04

Open *Tekon Configurator Software*¹ and select from the menu *DUOS >> Gateway >> Configuration*

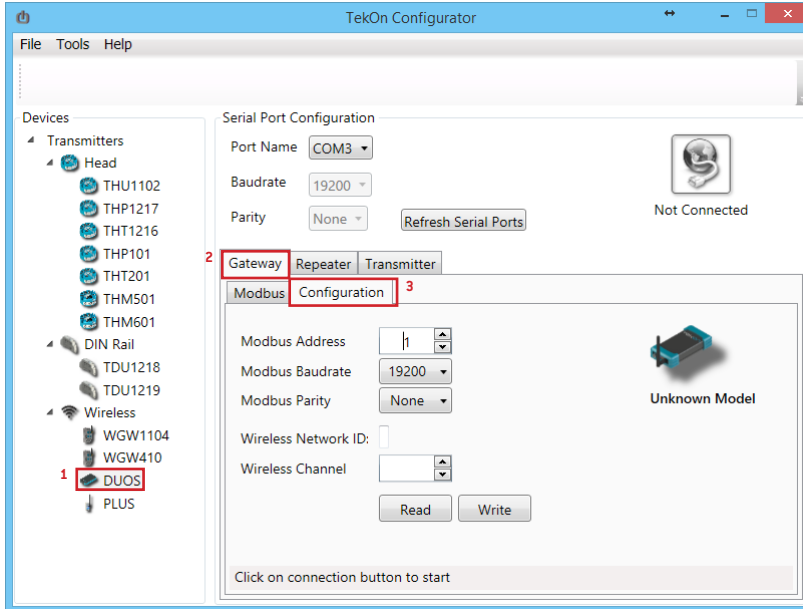

05

Select the Serial Port of the *DUOS Wireless Gateway*

Click on the *Refresh Serial Ports* button.

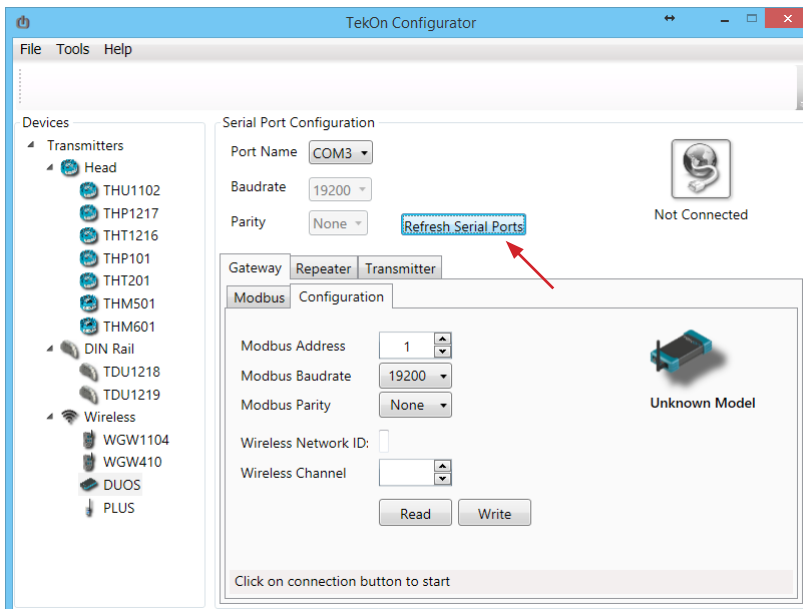

¹ Tekon Configurator software is free of charge and available at www.tekonelectronics.com

step

01

CONNECT AND CONFIGURE THE DUOS WIRELESS GATEWAY

06

Select the *Port name*² of the device.

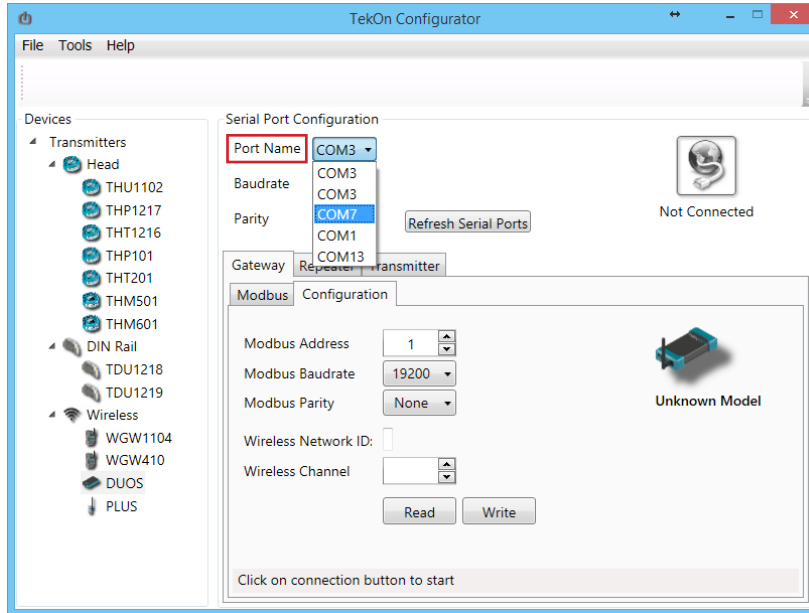

07

Remove the *DUOS RS485-USB* cable from the *Gateway* side and reinsert it.



NOTE:



After reinserting the cable, you have 10 seconds to enter in configuration mode by clicking on the Connect () button, while the blue LED flashes slowly. In this mode, you can manage the device parameters: *Modbus Address*, *Modbus baud rate*, *Modbus Parity*, *Wireless Network ID* and *Wireless Channel*.

² You can check the device port name in the Device Manager menu in the Windows operating system.

step
01

CONNECT AND CONFIGURE THE DUOS WIRELESS GATEWAY

08

Click on the *Connect* (🌐) button to enter configuration mode.

The status string at the bottom of the software window gives feedback of reading operations, as well as the *Gateway* LED indication.

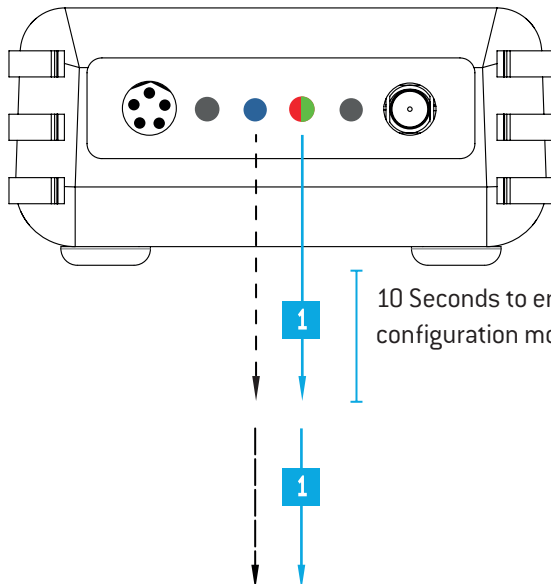
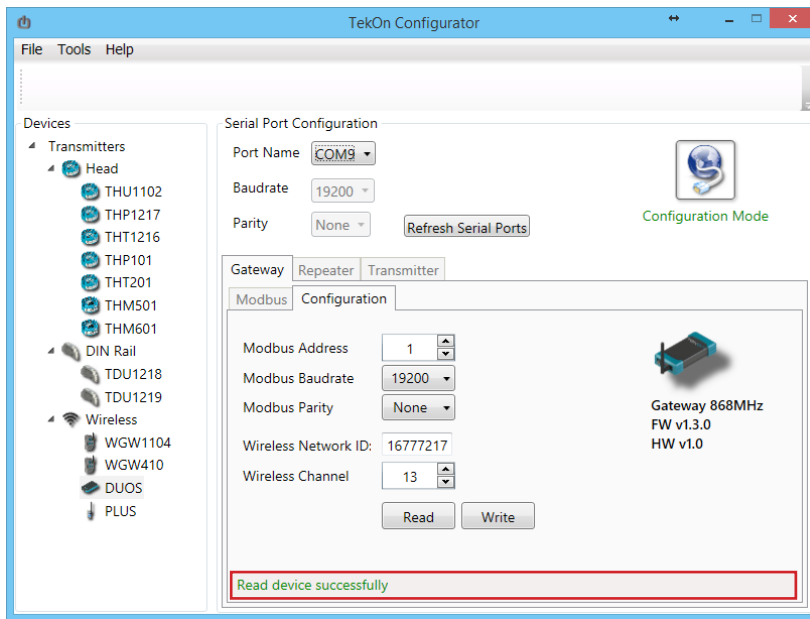

- LED flashes slowly
- LED flashes quickly
- 1** — LED switched on and steady



NOTE:

When 10 seconds have been exceeded, the blue LED is steady and it is no longer possible to enter configuration mode. In this case, the cable must be removed and reinserted - step 2.

step
01

CONNECT AND CONFIGURE THE DUOS WIRELESS GATEWAY

09

Take note of the device configuration data available, namely: *Modbus Address*, *Modbus Baudrate*, *Modbus Parity*, *Wireless Network ID* and *Wireless Channel*.

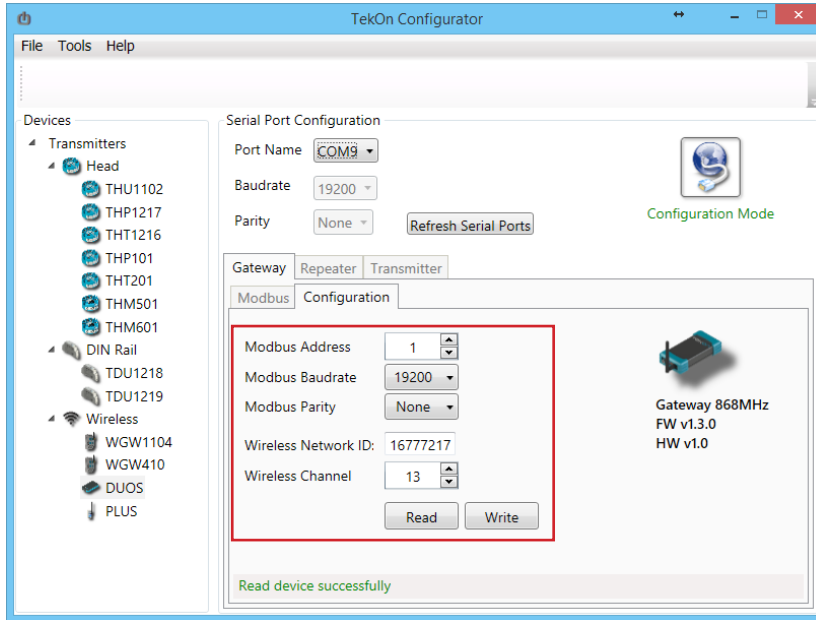

NOTE:

The wireless network connection between devices is ensured by the *Wireless Network ID* and *Wireless Channel* field parameters.

10

Click on the *Disconnect* (🌐) button.

The Modbus interface and the wireless network are active if the blue LED is on and steady and the red LED is flashing once per second.

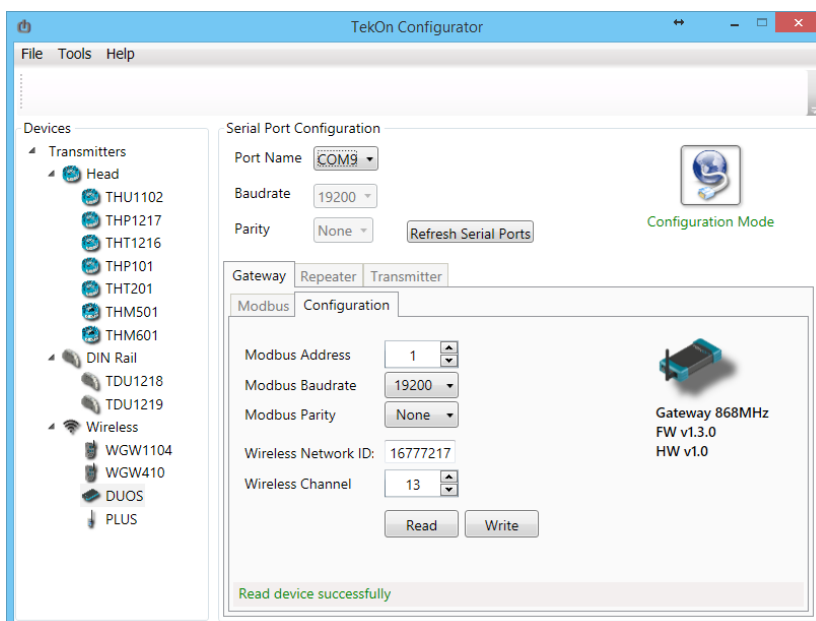

step
01

CONNECT AND CONFIGURE THE DUOS WIRELESS GATEWAY

11

Modbus Communication

Open the *Modbus* tab of the *Gateway* and set the previously saved configurations.

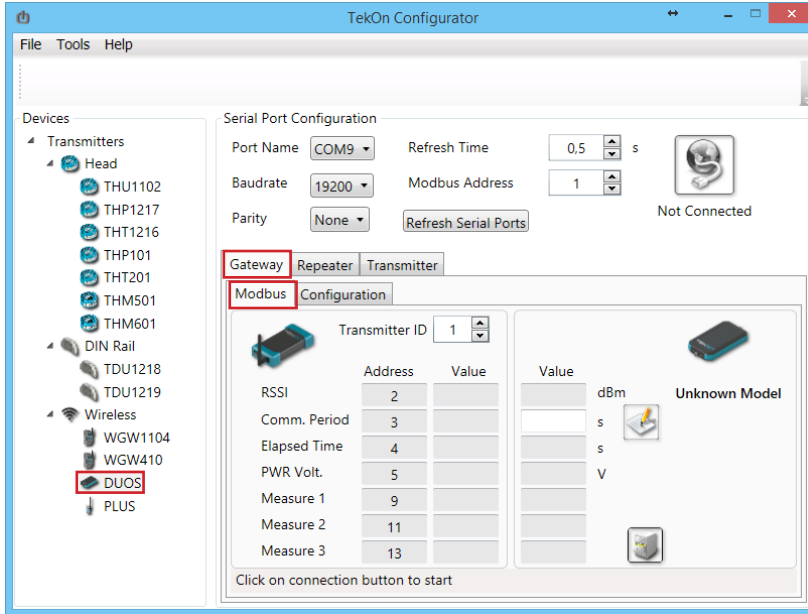

Ensure that the *Port name*, *Baudrate*, *Parity* and the *Modbus Address* fields are the same obtained in configuration mode.

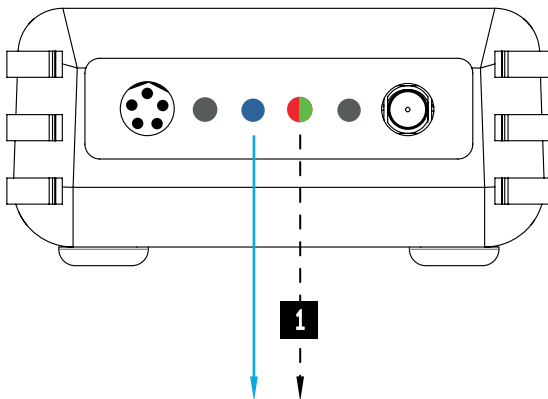

- LED switched on and steady
- 1** - - - - - Red LED flashes every second whenever it sends beacons to new elements to join the network.

step
01

CONNECT AND CONFIGURE THE DUOS WIRELESS GATEWAY

12

Click on the *Connect* (🌐) button and check the operation status at the bottom of the window.

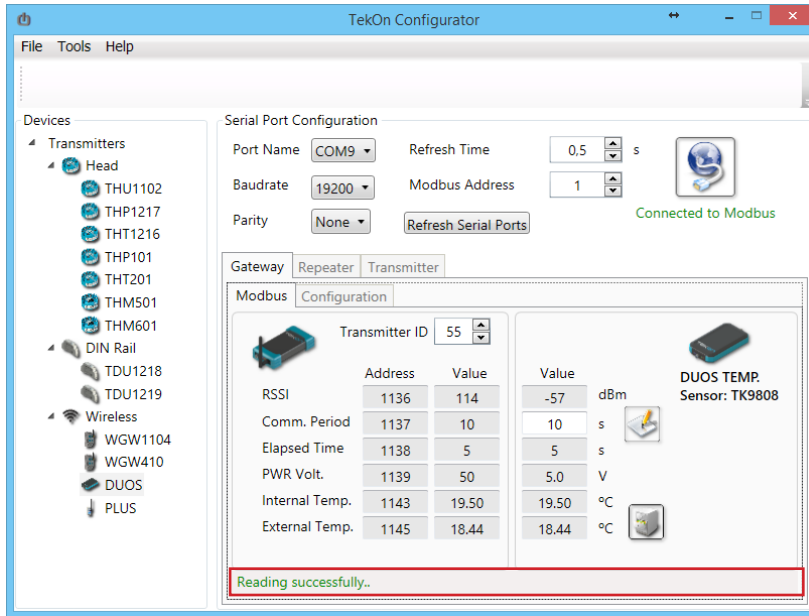

The messages *Connected to Modbus* and *Reading successfully* will appear if the *Serial Port* configuration parameters are correct and the Modbus connection established.
If the blue LED is on and steady and red LED flashes once per second, the *Gateway* is fully operational on the Modbus and wireless interfaces.

step

02

CONNECT AND CONFIGURE THE DUOS WIRELESS TRANSMITTER

The following steps are valid for any *Transmitter* from the *DUOS* system.

The device (previously mentioned as “unknown model”), as well as the firmware and hardware versions, will be detected when the USB is set. The Tekon Configurator software graphical interface is then adjusted to the detected device.

01

Connect probe to the *DUOS Wireless Transmitter*.

The *DUOS Temp Wireless Transmitter* is the device chosen for this guide.



NOTE:

Although the transmitters are physically equal, probe compatibility is different. This means that the *DUOS TEMP Wireless Transmitter* is only compatible with temperature probes (models: Plug and Play probe and Temperature Probe), whereas the *DUOS Hygrotemp Wireless Transmitter* is only compatible with temperature and humidity probes (models: TK07-PFT5 and TK07-MFT9-HC01).

02

Open a new window of the *Tekon Configurator Software* and select the menu *DUOS >> Transmitter*.

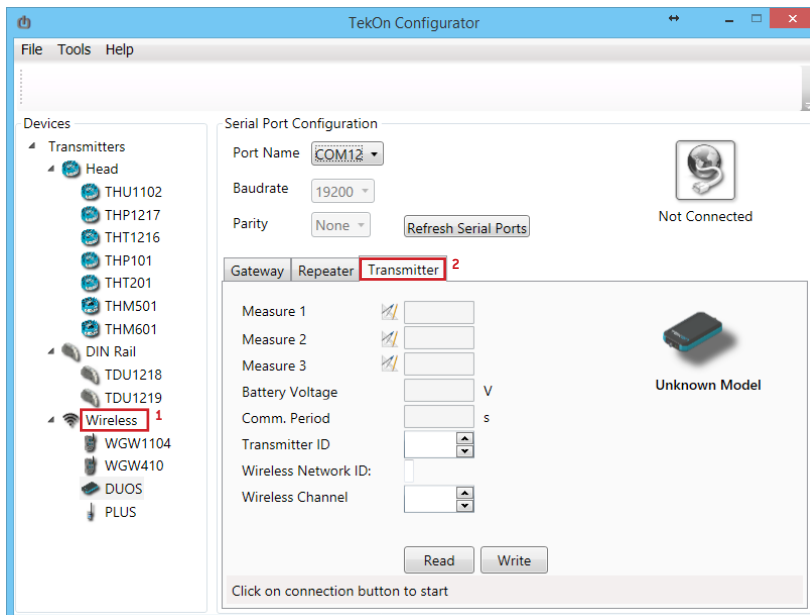

step

02

CONNECT AND CONFIGURE THE DUOS WIRELESS TRANSMITTER

03

Connect the *DUOS TRANSMITTER SARC* cable to the computer and then to the transmitter.

After cable connection, all LEDs stay active during 10 seconds.

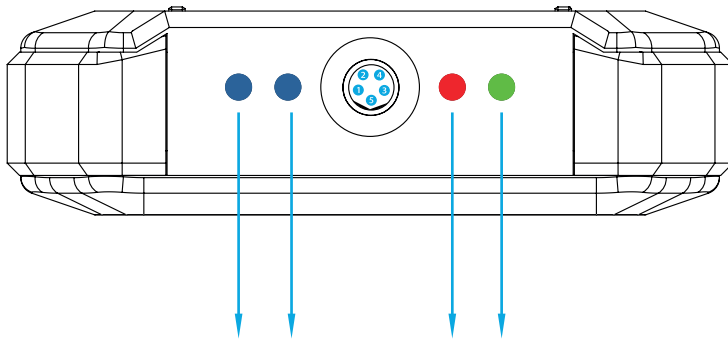

LED switched on and steady

04

Click on the *Refresh Serial Ports* button.

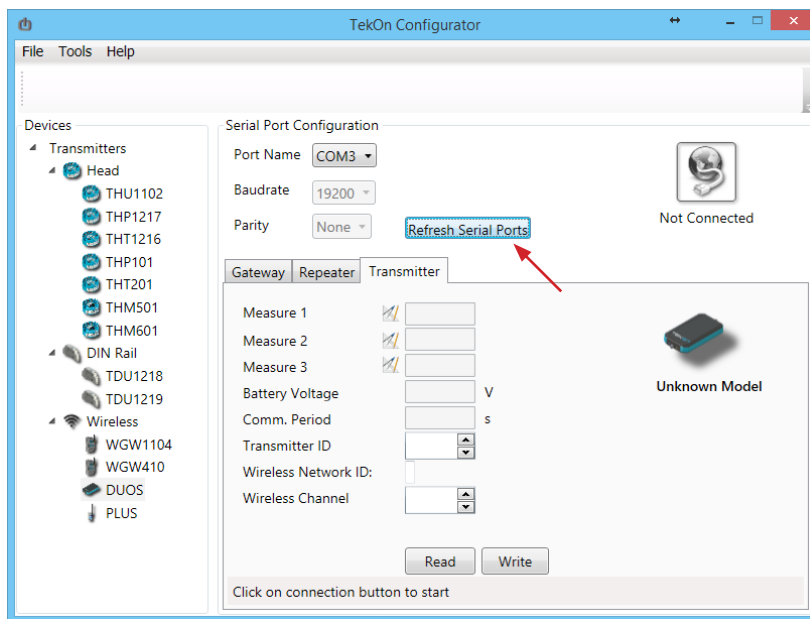

step

02

CONNECT AND CONFIGURE THE DUOS WIRELESS TRANSMITTER

05

Select the *Port name* of the device.³

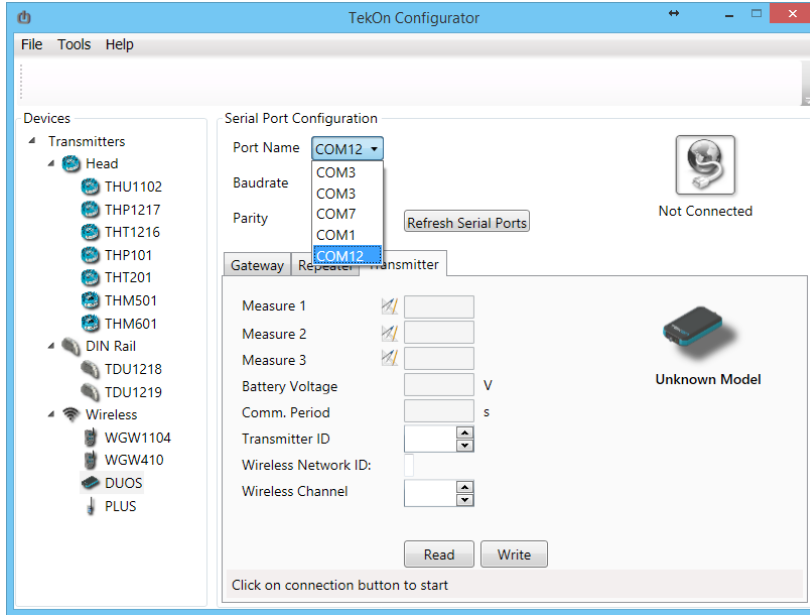

06

Remove the cable from the *Transmitter* side and reinsert it. This will access the device's configuration input window during 10 seconds.



³ You can check the device port name in the Device Manager menu in the Windows operating system.

step
02

CONNECT AND CONFIGURE THE DUOS WIRELESS TRANSMITTER

07

The status string at the bottom of the software window gives feedback on reading operations.

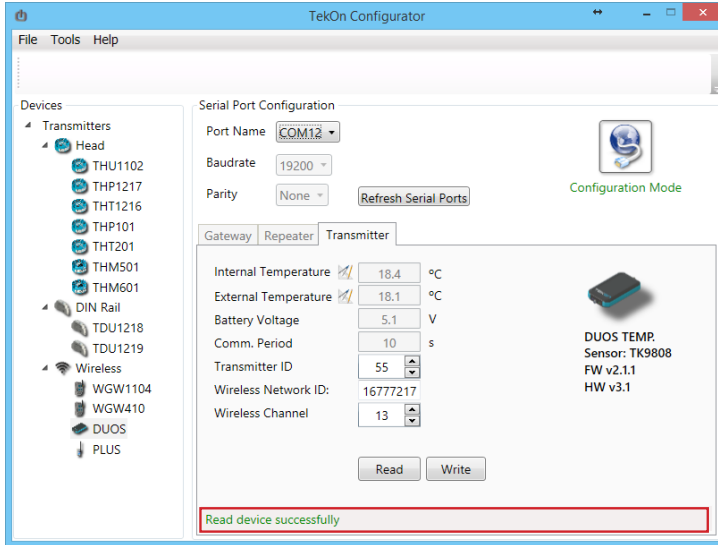

The device's identification data is now available in the software window. In this guide, the *DUOS TEMP Wireless Transmitter* has been considered.

Click on *Connect* (🔌) button to enter configuration mode. These configurations are read automatically.

In configuration mode, the *Transmitter* activates 4 LEDs: 2 blue LEDs flash and the red and green LEDs remain active and steady.

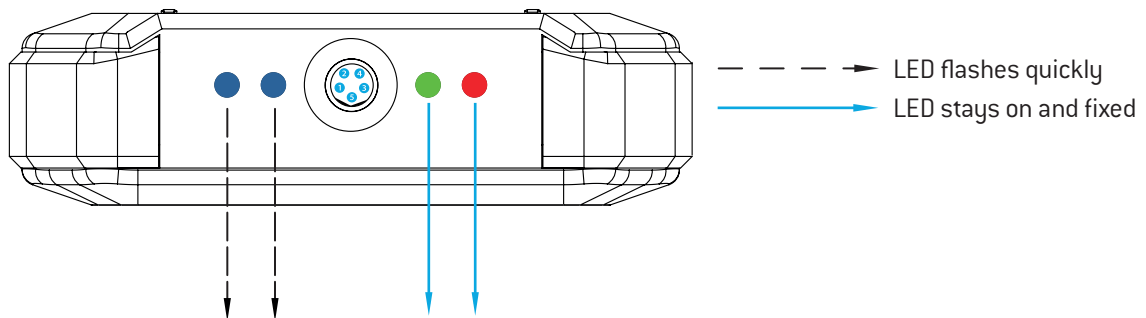

NOTE:

After reinserting the cable, you have 10 seconds to enter configuration mode by clicking on the *Connect* (🔌) button, while the blue LEDs flash slowly. When the 10 seconds have been exceeded, the blue LEDs are steady and it is no longer possible to enter configuration mode. In that case, the cable must be removed from the Transmitter and reinserted - step 3.

step

02

CONNECT AND CONFIGURE THE DUOS WIRELESS TRANSMITTER

08

Configure the *Wireless Network ID* and the *Wireless Channel* previously obtained from the *Gateway*. The wireless connection between both devices is ensured by the *Wireless Network ID* and the *Wireless Channel* parameters.

Ensure that the *Transmitter ID* is unique in the network. Each device must have a different *Transmitter ID*. Change it (if necessary) and take note to view the data later.

Click on the *Write* button to update the settings for the *Transmitter*.

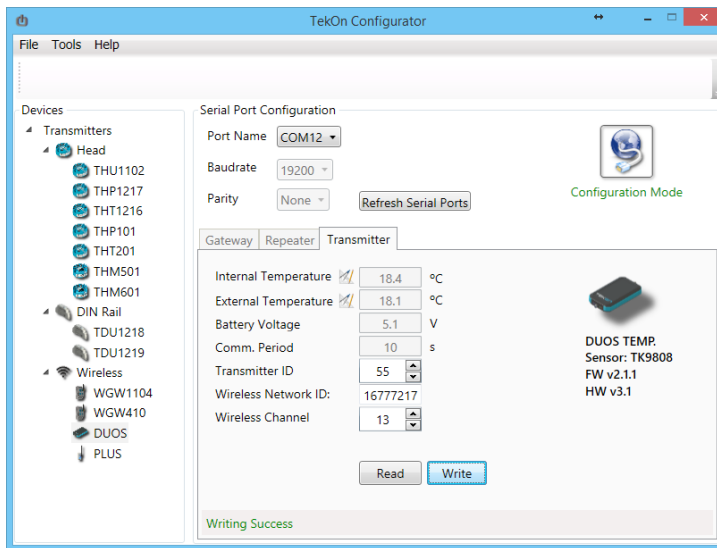

step
02

CONNECT AND CONFIGURE THE DUOS WIRELESS TRANSMITTER

09

Click on the *Configuration Mode* (🔗) button to exit setup and start the equipment in normal operation mode.

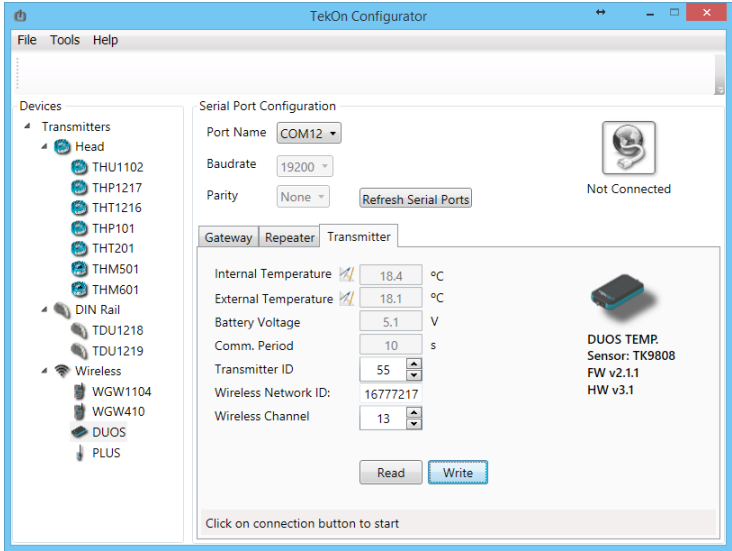

After this procedure:

- The *Transmitter* awaits connection to the *Gateway*, when only the red LED flashes;

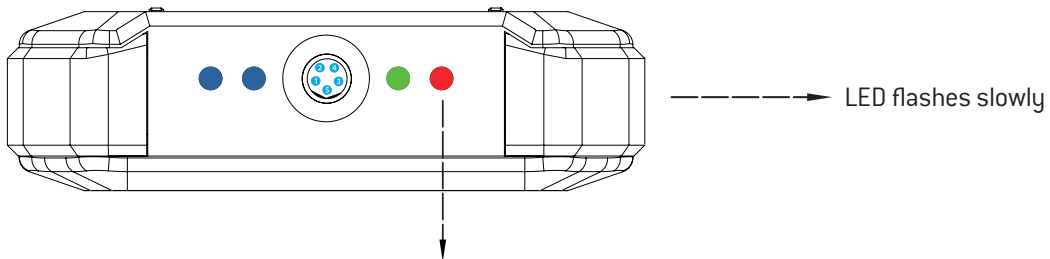

- The *Transmitter* is connected via wireless and its data is available in the *Gateway*, when the red and green LEDs flash.

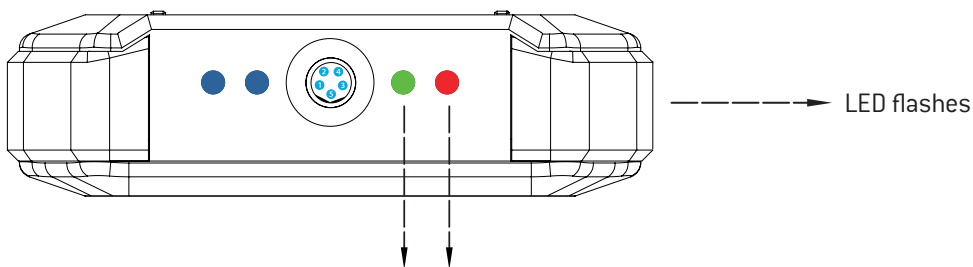

NOTE:

If the green LED does not flash, communication has not been established. Make sure that the devices are at a distance of at least 3 meters, or remove the antenna from the gateway (in case both devices are near each other). The *Transmitter LEDs* remain active during 1 minute. After this period, all LEDs shut down in order to optimise battery life.

To reset the transmitter, the batteries should be removed, during - at least - 50 seconds (in sleep mode) or instead, as the transmitter has a magnetic switch, a magnet can be used to reset it by passing the magnet close to the transmitter's front side in the blue LED's area.

step

03

CHECK WIRELESS COMMUNICATION BETWEEN THE DUOS TRANSMITTER AND THE GATEWAY

01

Place the two windows of Tekon Configurator software devices' side by side, in order to analyse communication between both devices.

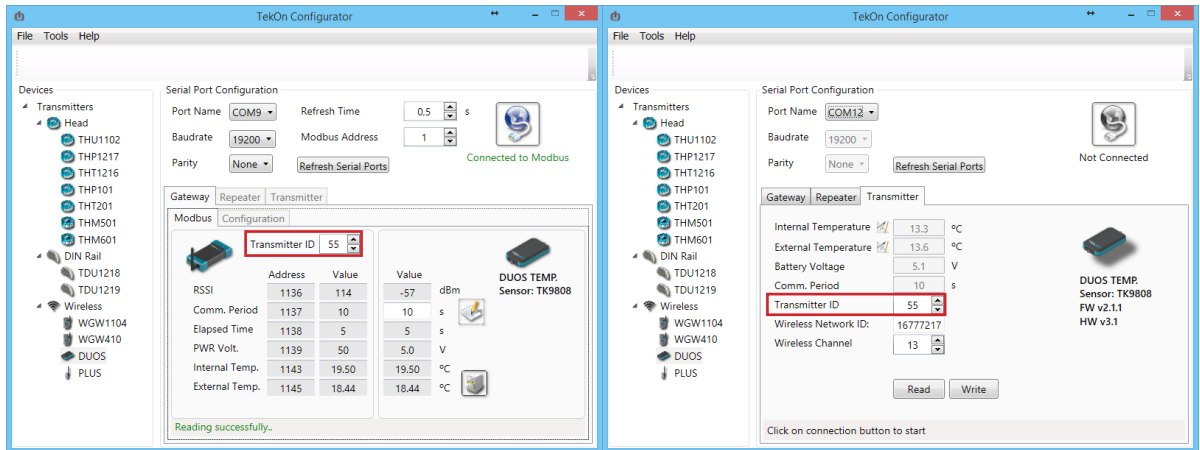

02

Select the configured *Transmitter ID* in the *Gateway* window. After this, it is possible to access the address window of the *Transmitter* in analysis.

The communication between devices is successful when the *Communication Period* field is in compliance with its duration cycle. Therefore, as soon as the cycle duration has finished, it will turn back to 0.

Communication does not occur if the *Elapsed Time* field presents a higher value than the *Communication Period* field.

In the following example, it was established that the temperature monitoring cycle (or *Communication Period*) is 10 seconds. Therefore, the *Elapsed Time* field will turn back to 0 as soon as it reaches 10 seconds and the analysed parameters (in this case, the temperature) will be updated in accordance with ambient conditions.

You can define the communication period of the *Transmitter* in the write field by clicking on the *register* () button.

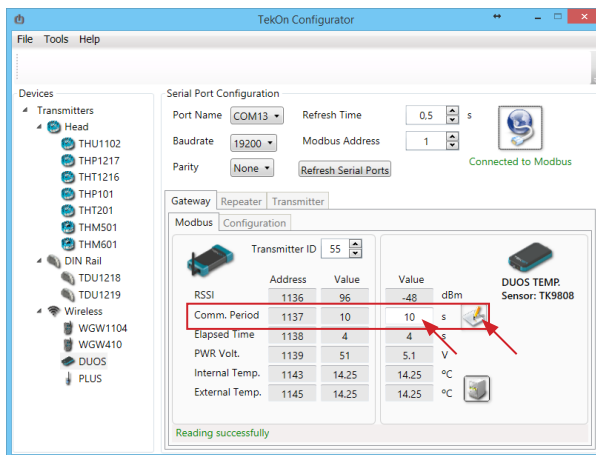

step

04

CONNECT AND CONFIGURE THE DUOS WIRELESS REPEATER

01

Connect the antenna to the *Repeater*.



02

Connect the *DUOS RS485-USB* cable to the computer and then to *Repeater*.

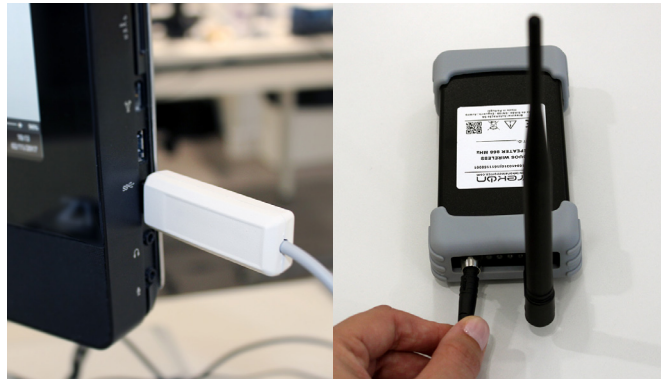

Check the device connection through the LEDs indication.

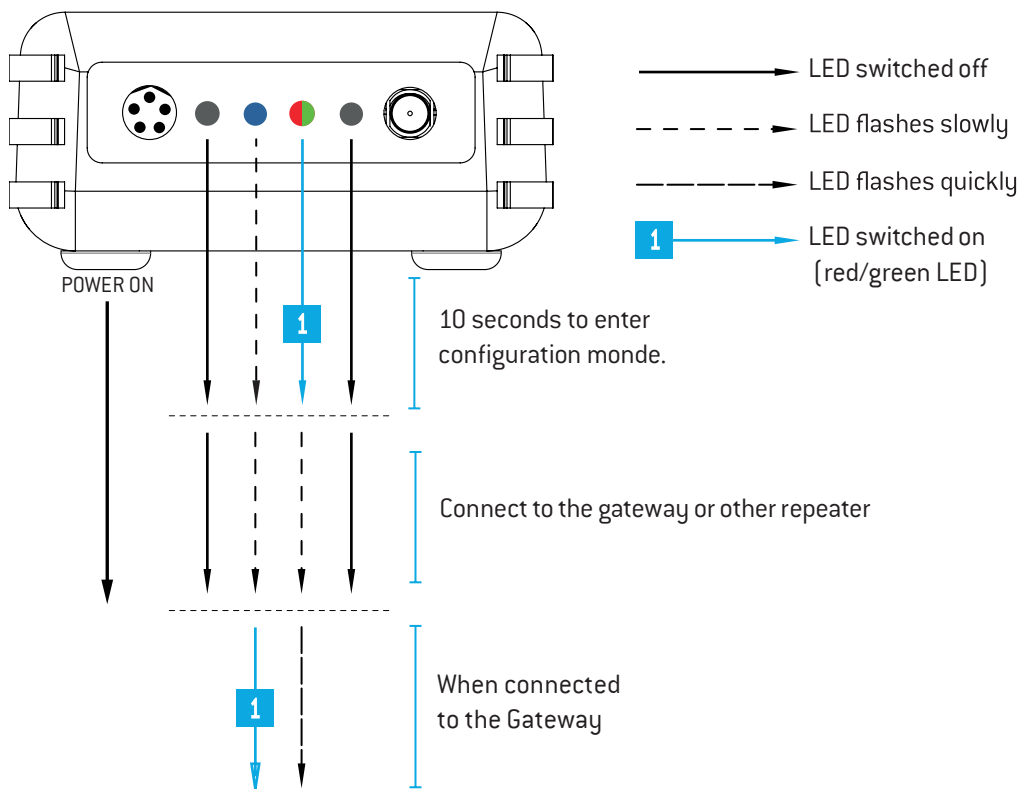

step

04

CONNECT AND CONFIGURE THE DUOS WIRELESS REPEATER

03

Open the *TekOn Configurator Software* and select the menu *DUOS >> Repeater*.

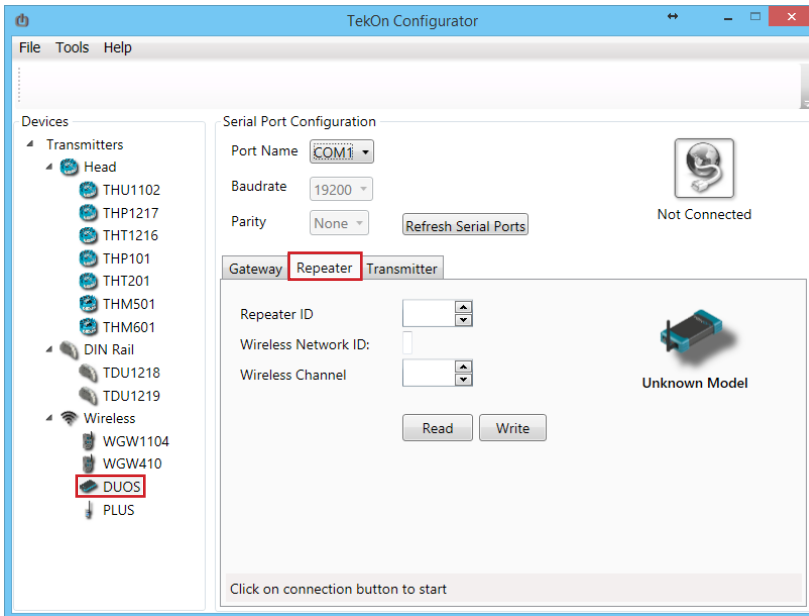

04

Click on *Refresh Serial Ports* button.

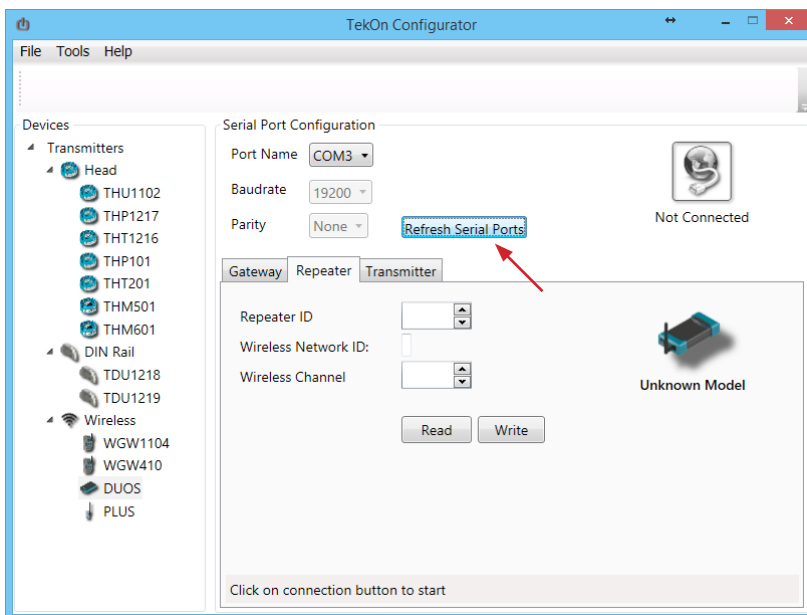

step

04

CONNECT AND CONFIGURE THE DUOS WIRELESS REPEATER

05

Select *Port name* of the device.⁴

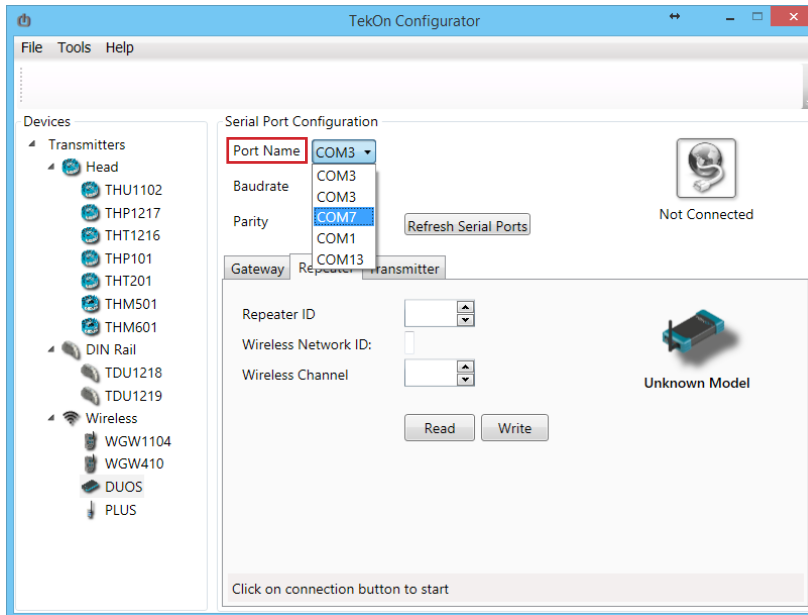

06

Remove the cable from *Repeater* and reinsert it. After reinserting the cable you have 10 seconds to enter configuration mode by clicking on the *Connect* (🔌) button, while the blue LED flashes slowly.



NOTE:

When the 10 seconds have been exceeded, the blue LED remains steady and it is no longer possible to enter *Configuration mode*. In that case, the cable must be removed from Repeater and reinserted.

⁴ You can check the device port name in the Device Manager menu in the Windows operating system.

step

04

CONNECT AND CONFIGURE THE DUOS WIRELESS REPEATER

07

Click on the *Connect* (🔌) button to verify the device's configuration data.

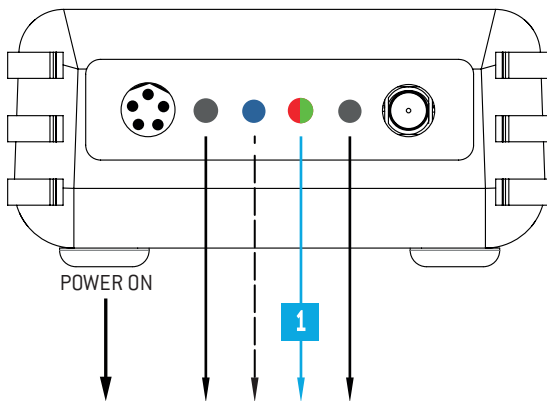
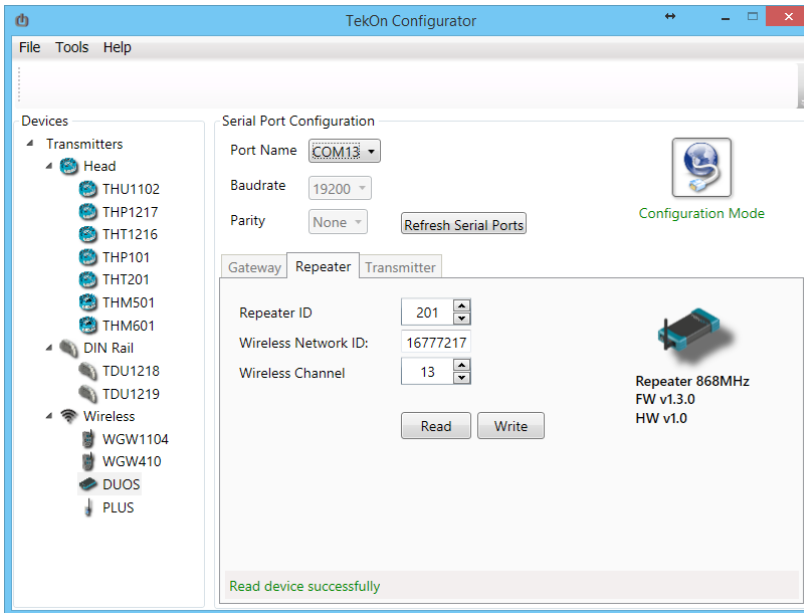

- ▶ LED switched off
- - - - -▶ LED flashes slowly
- - - - -▶ LED flashes quickly
- ▶ LED switched on (red/green LED)

step

04

CONNECT AND CONFIGURE THE DUOS WIRELESS REPEATER

08

Make sure that *Wireless Network ID* and *Wireless Channel* in the *Repeater* window have the same values as the ones that were obtained in the *Gateway* configuration window.

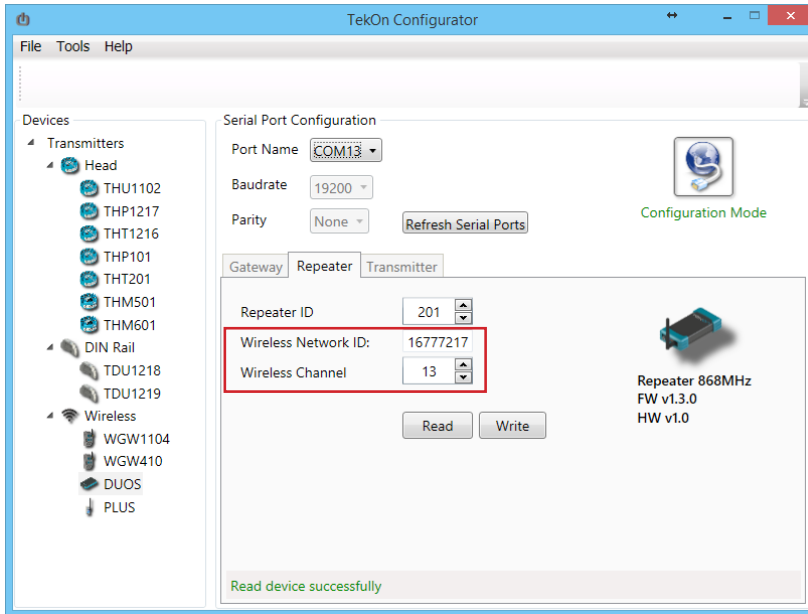

NOTE:

If there is more than one *Repeater* in the network, make sure that the *Repeater ID* is unique in order to avoid network conflict.

09

Change configuration fields (if necessary) and click on *Write* (📄) button to update the *Repeater ID* parameter.

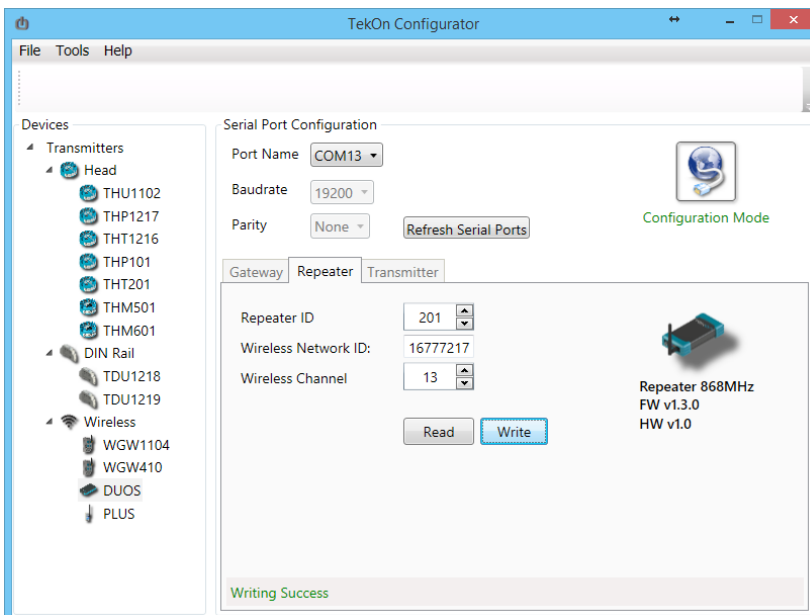

step

04

CONNECT AND CONFIGURE THE DUOS WIRELESS REPEATER

10

Click on the *Configuration Mode* (🌐) button to exit the setup programme.

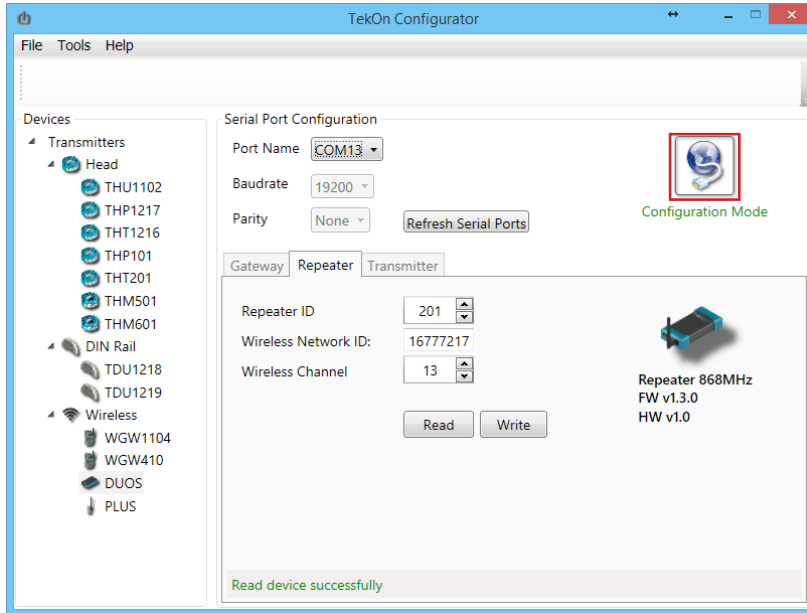

NOTE:

In order to establish communication between the Repeater and the Gateway, make sure that both devices are at a distance of at least 3 meters or remove the antenna from the repeater (in case both devices are near each other). These procedures will guarantee communication quality.

At this moment, it is possible to check if:

- The *Repeater* is trying to connect to the network when the red LED flashes every second.

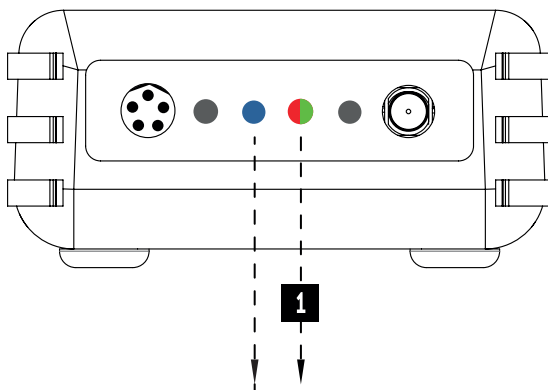

- LED flashes slowly
- 1** --- Red LED flashes until communication can be established

step

04

CONNECT AND CONFIGURE THE DUOS WIRELESS REPEATER

- The *Repeater* is connected to the wireless network when red and green LEDs flash.

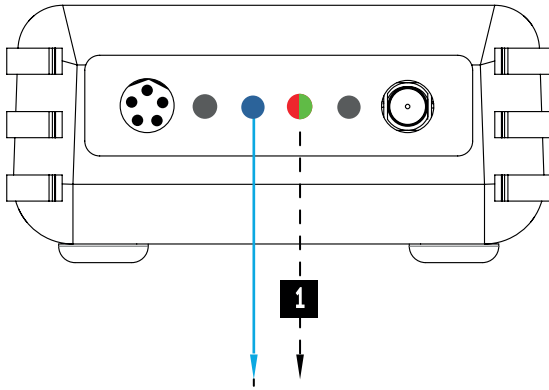

LED switches on and remains steady

1 Red/green LED flashes as soon as connection between the devices has been established.

step

05

CONNECT THE DUOS WIRELESS IoT GATEWAY

01

Change the switch pin to *Normal Mode*.

Plug the ethernet cable that follows with your gateway to the device's input and to your network.



02

Your **DUOS IoT GATEWAY** physical connection should look like this.



WIFI



The access through this interface only allows the configuration and consultation of **DUOS IoT GATEWAY**. Unable to send data to the cloud over this channel.

The **DUOS IoT GATEWAY** appear with an SSID with the following configuration *WGW4IoT-hostname*. By default, the devices follow with the SSID *WGW4IoT-<serialnumber>*

03

Connect to the wifi network that comes from your gateway.

Use the password *bresimar* to login.

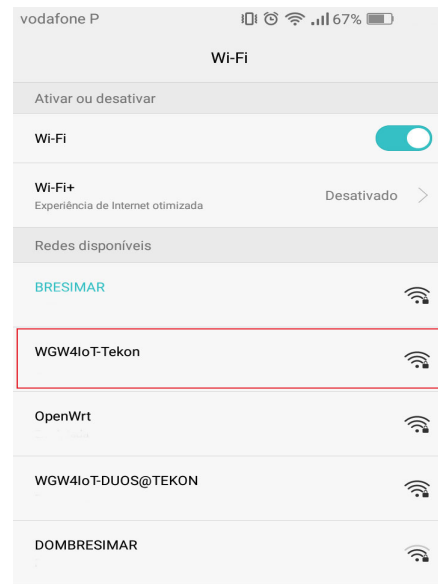

step
05 | CONNECT THE DUOS WIRELESS IoT GATEWAY

DUOS IoT GATEWAY has a fixed IP address assigned to be accessed via mobile phone, tablet or pc (through Wi-Fi). The interface designed to interact with the device can be accessed through its fixed IP [192.168.128.1] or its SSID address [http://Tekon]. The factory-defined and configurable access data are:

- **Login:** admin
- **Password:** admin



NOTE:

This password and username must be changed to improve the security level.



NOTE:

After a power-on cycle, the first access to the gateway may have a long time waiting time and should not be confused with a lack of response.



NOTE:

SSID address access is only possible until it is changed. After the change, you must access by the user-defined SSID.

04

Check your network credentials. Click on [Settings](#) >> [IP Network](#) tab.

By default, your gateway has a static ethernet IP address for the network [192.168.100.1]. You can choose to keep this IP address or activate the DHCP feature to be assigned a dynamic IP address by the network.

The screenshot shows the Tekon IoT Gateway web interface. The top navigation bar includes 'HOME', 'SENSOR NETWORK', 'SETTINGS', and 'ADMIN'. The 'SETTINGS' tab is active, and the 'Network' sub-tab is selected. Below the navigation bar, there is a table titled 'IP Network Table' with the following data:

Interface	DHCP	IP Address	Netmask	Gateway	MAC Address	
eth0	Disabled	192.168.100.1	255.255.255.0	192.168.0.250	40:a3:6b:c2:1c:4c	Manage
lo	Disabled	127.0.0.1	255.0.0.0		00:00:00:00:00:00	
ra0	Disabled	192.168.128.1	255.255.255.0		40:a3:6b:c2:1c:4a	

Below the table, there is a section for NTP configuration with a text input field containing 'pt.pool.ntp.org' and an 'Update' button. There is also a 'Test' button. Below that is a section for Proxy Configuration with input fields for HTTP Proxy and HTTPS Proxy, and an 'Update' button.

step
05 | CONNECT THE DUOS WIRELESS IoT GATEWAY

05 To enable the option to get an dynamic IP address assigned by your network, click on *Manage* button.

The screenshot shows the Tekon IoT Gateway settings page. The 'IP Network Table' section contains a table with the following data:

Interface	DHCP	IP Address	Netmask	Gateway	MAC Address	
eth0	Disabled	192.168.100.1	255.255.255.0	192.168.0.250	40:a3:6b:c2:1c:4c	<input checked="" type="checkbox"/> Manage
lo	Disabled	127.0.0.1	255.0.0.0		00:00:00:00:00:00	
ra0	Disabled	192.168.128.1	255.255.255.0		40:a3:6b:c2:1c:4a	

Below the table, there is an 'NTP' section with a text input field containing 'pt.pool.ntp.org' and buttons for 'Test' and 'Update'. A 'Proxy Configuration' section is also visible at the bottom.

06 A pop-up window will show up. Click on the validation box, next to the *DHCP* label to enable the option and click on the *Update* button to save the changes. You will be redirected to the previous page.

The screenshot shows a 'Manage interface eth0' pop-up window. The 'DHCP' checkbox is checked and highlighted with a red box. The 'Update' button at the bottom right of the window is also highlighted with a red box. The background shows the same IP Network Table as in the previous step.



Write down the IP address of your device's ethernet port. It will be needed later.

step
05 | CONNECT THE DUOS WIRELESS IoT GATEWAY

CONFIGURE A PROXY SERVER (OPTIONAL)

07 You can configure a proxy server to your gateway. Go to the *Settings >> Network >> Proxy Configuration*. Complete the **HTTP Proxy** and **HTTPS Proxy** fields with the **correct address** of your proxy server.

Click on the *Update* button to save the changes.

Interface	DHCP	IP Address	Netmask	Gateway	MAC Address
eth0	Disabled	192.168.100.1	255.255.255.0	192.168.0.250	40:a3:6b:c2:1c:4c
lo	Disabled	127.0.0.1	255.0.0.0		00:00:00:00:00:00
ra0	Disabled	192.168.128.1	255.255.255.0		40:a3:6b:c2:1c:4a

Showing 1 to 3 of 3 entries

NTP

NTP Peer:

Proxy Configuration

HTTP Proxy:

HTTPS Proxy:

NOTE: The proxy address must consider the full path configuration like in the example: 'http://my.proxy.com:9000' or 'https://my.secure.proxy.com:9000'

step

05

CONNECT THE DUOS WIRELESS IoT GATEWAY

ACCESS TO DUOS GATEWAY IOT THROUGH ETHERNET

08

The connection to **DUOS IoT GATEWAY** through Ethernet is made using your web browser. You can access by the hostname (`http://<hostname>`) or via IP address (`http://<192.168.100.1>`).

The default login credentials are:

- **Login:** admin
- **Password:** admin

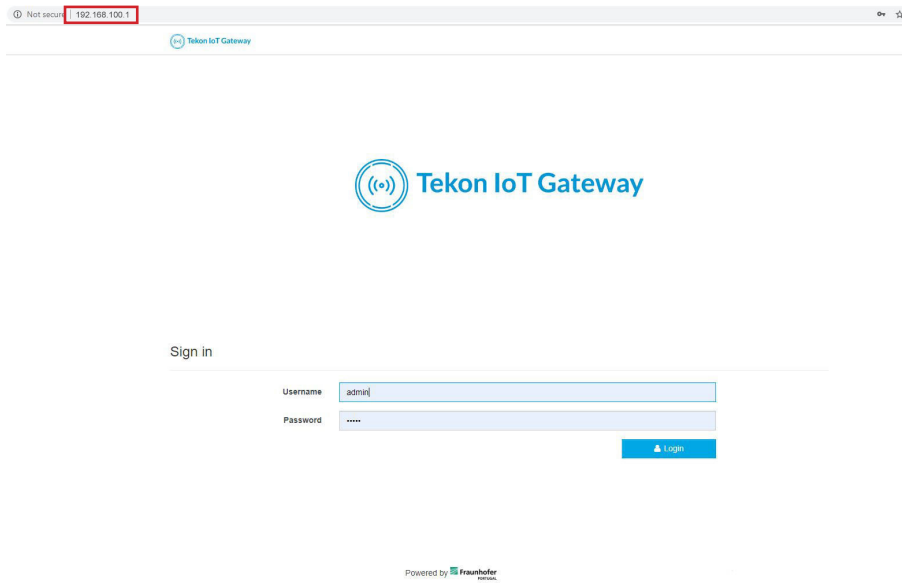

NOTE:

DUOS IoT GATEWAY access credentials displayed by default can be edited in *Settings* » *Users* menu.

step
05 | CONNECT THE DUOS WIRELESS IoT GATEWAY

TRANSMITTER ACTIVATION

09

At login, the graphical interface displays the transmitters that are connected to the network. The first presentation of the devices connected to the network is through a vertical listing (1). To get an overview of your system, at the bottom of the main page, you will find information about the activity and links established (2).

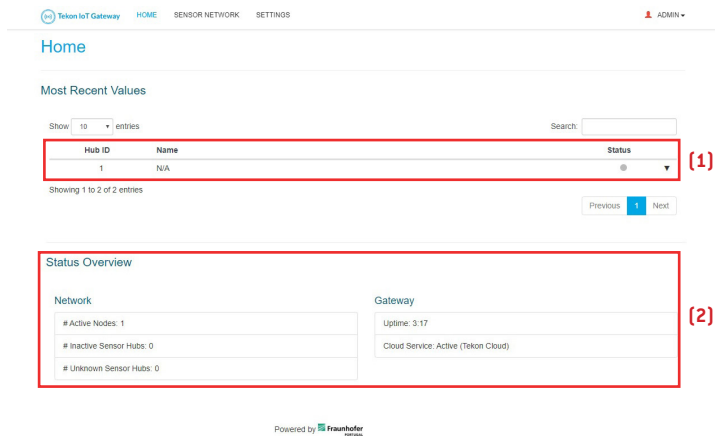

The transmitters are listed in ascending numerical order. By default, the name appears with “N/A” until it is edited and reset. The *Hub ID* field match to the *Transmitter ID* field defined in *Tekon Configurator* over the transmitter configuration.

10

Click on the *Hub ID* field of the transmitter to activate. You will be redirected to the selected transmitter page, select the *Properties* tab (1), in the *Status* property, choose the *Active* state (2) and click on the *Update* button (3) to save the change.

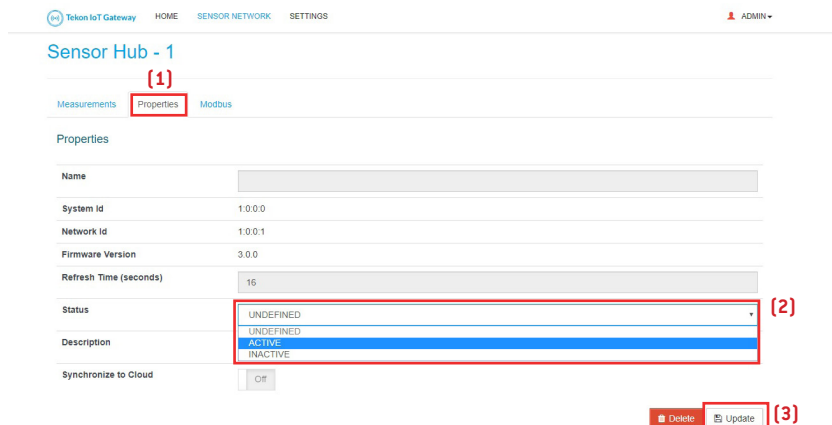

step
05 | CONNECT THE DUOS WIRELESS IoT GATEWAY



The transmitter is activated.
Transmitter information available for all the interfaces.



If you would like to send data from this transmitter to Tekon IoT Platform, set the *Synchronize to Cloud* field to *On* mode and save the changes. We will return to this subject shortly.

11

In the "Properties" tab, fill in the fields:

- **"Name"** and **"Description"** according to your preference;
- **"Refresh Time"** according to the intended transmitter communication period;

Save the changes in the *Update* button.

Tekon IoT Gateway HOME SENSOR NETWORK SETTINGS ADMIN

Sensor Hub - 1

Measurements Properties Modbus

Properties

Name	DUOS CO2 - Comercial Warehouse
System Id	1:0:0:0
Network Id	1:0:0:1
Firmware Version	3.0.0
Refresh Time (seconds)	16
Status	ACTIVE
Description	Black DUOS CO2 transmitter in comercial warehouse

Synchronize to Cloud Off

Delete Update



The transmitter is configured.

step
05 | CONNECT THE DUOS WIRELESS IoT GATEWAY

CONNECTION TO TEKON IOT PLATFORM

12

In the DUOS IoT GATEWAY page, go to [Settings](#) >> [Cloud Services](#).

The screenshot shows the Tekon IoT Gateway web interface. The top navigation bar includes 'Tekon IoT Gateway', 'HOME', 'SENSOR NETWORK', and 'SETTINGS' (highlighted with a red box). Below this is the 'Settings' page with sub-tabs: 'Communication Module', 'Users', 'Data Import/Export', 'Network', 'Cloud Services' (highlighted with a red box), 'Monit.', and 'System'. The 'Tekon Cloud' section contains a 'Server URL' field with 'http://iot19.tekonelectronics.com/', an 'API Key' field with a long alphanumeric string, and a 'Status' toggle set to 'On'. There are buttons for 'Test Credentials', 'Validate Credentials', and 'Update'. Below this is the 'Tekon Cloud - Sensor hubs configuration' section, which includes a table with columns 'Hub ID', 'Name', and 'Status'. The table contains one entry: Hub ID '1', Name 'DUOS CO2 - Commercial Warehouse', and Status 'Cloud Synchronization Off'. There are also search and pagination controls.

13

In a new browser page, access your Tekon IoT Platform and go to [Settings](#) >> [Administration](#).

The screenshot shows the Tekon IoT Platform dashboard. The top navigation bar includes 'DASHBOARD', 'DATASOURCES', 'ALARMS', and 'DATA'. The 'SETTINGS' menu is highlighted with a red box, and its sub-menu is open, showing 'LANGUAGE', 'PERSONAL AREA', 'ADMINISTRATION' (highlighted with a red box), and 'CONFIGURATION'. The main content area shows a 'INSYS' section with a message 'Could not find any information for the following datasources'. Below this are three data cards: 'Humidity' at 53.5%, 'Temperature' at 28°C, and 'Counter' at -310471. The footer contains the copyright information: '© 2019 - BRESMAR AUTOMAÇÃO, S.A.'.

step
05 | CONNECT THE DUOS WIRELESS IoT GATEWAY

14

Click on the view option to see the *gateway* user data and copy the API key.

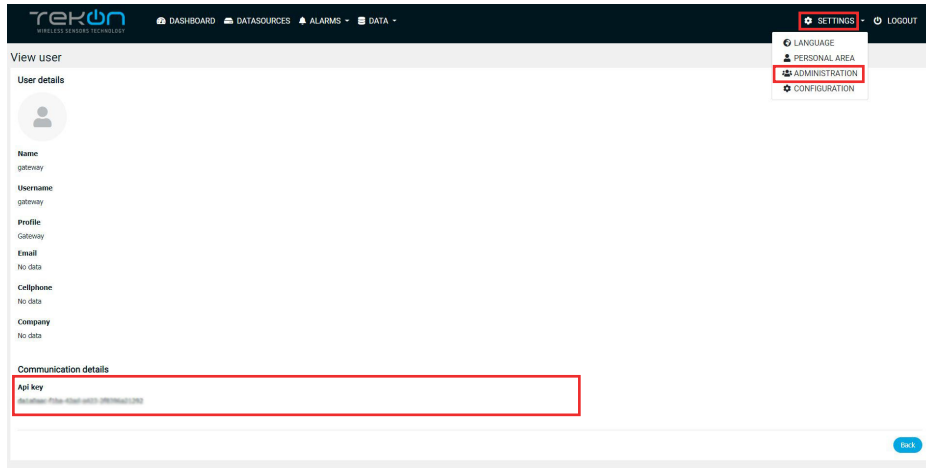

15

In the **DUOS IoT GATEWAY** page, fill in the fields:
 - **“Server URL”** with your Tekon IoT Platform address;
 - **“API Key”** with the Api key previously copied;

Change the *Status* field value to *On*.

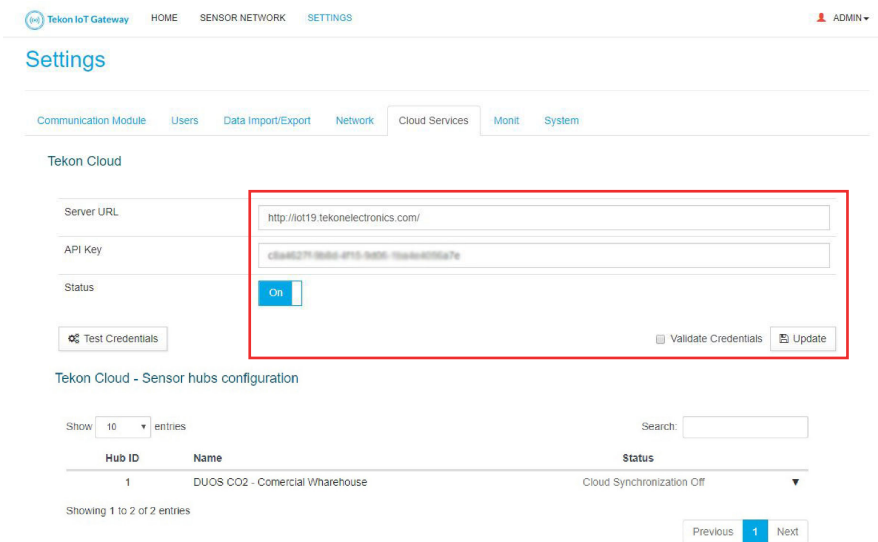

step
05 | CONNECT THE DUOS WIRELESS IoT GATEWAY

16

You can test the credentials declared. Click on *Test Credentials* button to test the credentials authenticity. If the credentials are authentic, a success message will show next to the button.

You can validate the credentials. This step will ensure data the credentials entered are authentic. Click on the *Validate Credentials* checkbox.

Click on *Update* button to save the changes. If *Validate Credentials* is checked, the configured data is stored only if valid. Pay attention to the received message.

Tekon IoT Gateway HOME SENSOR NETWORK SETTINGS ADMIN

Settings

Communication Module Users Data Import/Export Network Cloud Services Monit System

Tekon Cloud

Server URL

API Key

Status On

Authentication Ok Validate Credentials

Tekon Cloud - Sensor hubs configuration

Show 10 entries Search:

Hub ID	Name	Status
1	DUOS CO2 - Comercial Warehouse	Cloud Synchronization Off

Showing 1 to 2 of 2 entries

Previous 1 Next

Your DUOS GATEWAY IoT is now connected to your Tekon IoT Platform instance.



step
05 | CONNECT THE DUOS WIRELESS IoT GATEWAY

ATTACH TRANSMITTER DATA TO TEKON IOT PLATFORM

18

Access to your Tekon IoT Platform, click at the *Datasources* menu and the button (✎) to edit the datasource where you want to send the transmitter data.

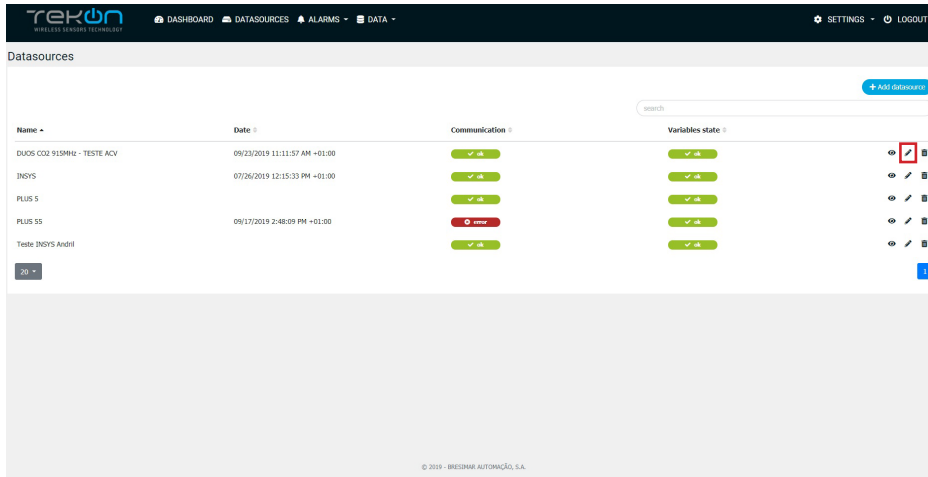

19

Copy the API key from the datasource and go back to your DUOS IoT GATEWAY page. On the page, select the transmitter you want to match, fill in the *API Key* field with the copied value.

You can test and validate the credentials, as explained in the step 16.

Click on *Update* button to save the changes.

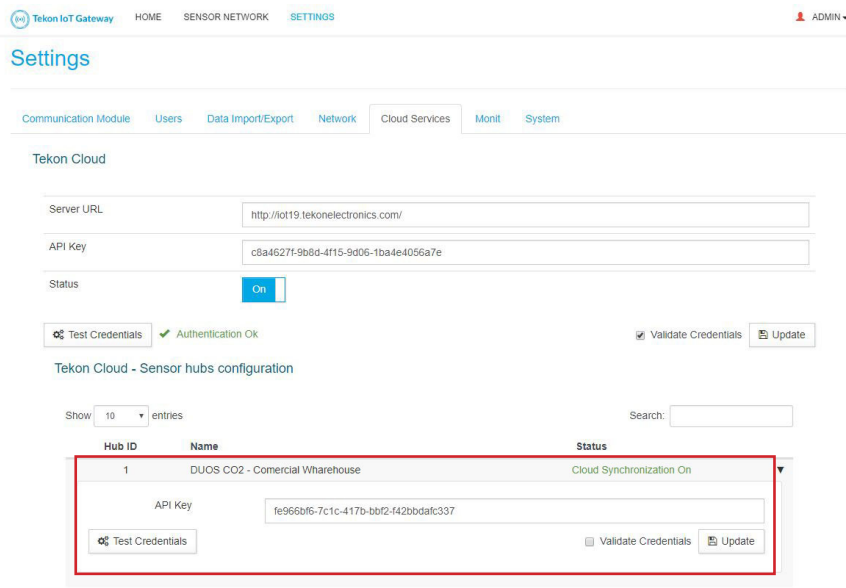

step
05 | CONNECT THE DUOS WIRELESS IoT GATEWAY



NOTE:

The message “Cloud Synchronization On” will only be visible if you have activated the option “Synchronize to Cloud” in the “TRANSMITTER ACTIVATION” step to activate your transmitter. If you did not perform the validation, the message “Cloud Synchronization Off” will be displayed in the “Status” field.



Your transmitter is now connected to your Tekon IoT Platform.



NOTE:

Perform a reboot in the gateway. Remove the *DUOS RS485-USB* cable on the gateway port and reconnect it.

VERIFY COMMUNICATION WITH TEKON IOT PLATFORM

20

To verify if the information acquired by the transmitter is effectively reaching your [Tekon IoT Platform](#), click on the [Datasources](#) menu and check the date of the latest communication between the platform and the transmitter. This log will tell you if the communication process is on or not.

Name	Date	Communication	Variables state
DUOS CO2 915MHz - TESTE ACV	09/23/2019 11:11:57 AM +01:00	✔	✔
INSYS	07/26/2019 12:15:33 PM +01:00	✔	✔
PLUS S		✔	✔
PLUS S5	09/17/2019 2:48:09 PM +01:00	✘ error	✔
Teste INSYS Andril		✔	✔

step
05 | CONNECT THE DUOS WIRELESS IoT GATEWAY

DATA COMMUNICATION OVER MODBUS TCP/IP

21

You can pre-check the **DUOS IoT GATEWAY** graphical interface of Modbus TCP/IP communication. In each transmitter you can analyze different common parameters in modbus communications.

Click on the transmitter / hub you want to analyze and select the **Modbus** tab.

Sensor Hub - 40

Measurements Properties **Modbus**

Modbus

Show 25 entries Search:

Register Variable	Actual Value	Register Address	Register Value	Register Type	Register Format
Transmitter Model	DUOS TEMP	819	0x000003	Holding Register	UINT16
Probe Sensor Model	TK9808	820	0x000001	Holding Register	UINT16
RSSI	-22	821	0x00002C	Holding Register	UINT16
Communication Period	60	822	0x00003C	Holding Register	UINT16
Elapsed Time	33	823	0x000021	Holding Register	UINT16
Power Supply Voltage	5	824	0x000032	Holding Register	UINT16
FW Version Major Minor	3.0	825	0x000300	Holding Register	UINT8_UINT8
FW Version Revision	0	826	0x000000	Holding Register	UINT16
HW Version Major Minor	3.3	827	0x000303	Holding Register	UINT8_UINT8
Last Internal Temperature	20.69	828	0x41A58106	Holding Register	DOUBLE
Last Temperature	20.44	830	0x41A38106	Holding Register	DOUBLE

Showing 1 to 11 of 11 entries

22

In this page, you have the selected transmitter modbus scheme.

- (1): variable names;
- (2): current value recorded;
- (3): modbus address;
- (4): register value;
- (5): register type;
- (6): register data type;

Sensor Hub - 40

Measurements Properties Modbus

Modbus

Show 25 entries Search:

(1) Register Variable	(2) Actual Value	(3) Register Address	(4) Register Value	(5) Register Type	(6) Register Format
Transmitter Model	DUOS TEMP	819	0x000003	Holding Register	UINT16
Probe Sensor Model	TK9808	820	0x000001	Holding Register	UINT16
RSSI	-22	821	0x00002C	Holding Register	UINT16
Communication Period	60	822	0x00003C	Holding Register	UINT16
Elapsed Time	33	823	0x000021	Holding Register	UINT16
Power Supply Voltage	5	824	0x000032	Holding Register	UINT16
FW Version Major Minor	3.0	825	0x000300	Holding Register	UINT8_UINT8
FW Version Revision	0	826	0x000000	Holding Register	UINT16
HW Version Major Minor	3.3	827	0x000303	Holding Register	UINT8_UINT8
Last Internal Temperature	20.69	828	0x41A58106	Holding Register	DOUBLE
Last Temperature	20.44	830	0x41A38106	Holding Register	DOUBLE

Showing 1 to 11 of 11 entries

step

05

CONNECT THE DUOS WIRELESS IoT GATEWAY



NOTE:

In this example we used the transmitter / hub 1. The first modbus address of its variables starts at 0. To find the modbus address calculation formula defined for DUOS IoT GATEWAY, please refer the datasheet on Tekon Electronics website.



To access to the records via [Modbus TCP/IP](#) in real time, you must use a program developed for this purpose, external to Tekon Electronics.

Configuration of Modbus TCP/IP:

- [DUOS IoT GATEWAY](#) IP;
- Port: 1502;

TEKON ELECTRONICS
a brand of Bresimar Automação S.A.

Quinta do Simão
3800-230 Aveiro
PORTUGAL

P.: +351 234 303 320
M.: +351 933 033 250
E.: sales@tekonelectronics.com

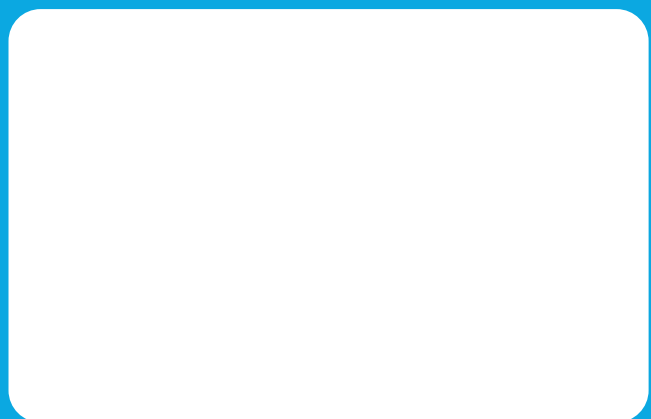

Cofinanciado por:



UNIÃO EUROPEIA
Fundo Europeu
de Desenvolvimento Regional