

TEMPERATURE WIRELESS TRANSMITTER PLUS TWPH-1UT



The Wireless Temperature Transmitter TWPH-1UT is specifically designed to meet the most rigorous requirements of temperature monitoring in industrial process environments. In its high power mode it can communicate over a long distance range.

The Wireless Temperature Transmitter TWPH-1UT accepts the most commonly used temperature sensors.

Its dual operating mode allows it to work as an end device for temperature measure and as a repeater to improve network redundancy.

Dimensions: 45 mm x 23 mm

Weight: Approx. 50g

Material: Nylon 66

Protection Index: IP40

KEY FEATURES

ULTRA LOW POWER MODE

UP TO 4 KM COMMUNICATION DISTANCE (LoS)

WIRELESS SITE SURVEY FUNCTION

FOR EASY INSTALLATION AND FAST DEVELOPMENT

WIDE RANGE SUPPLY VOLTAGE

FROM 5 TO 24V DC

MULTI-HOP MESH NETWORK

WITH SELF-FORMING, SELF-HEALING, SELF-OPTIMIZING FEATURES

UNIVERSAL SENSOR INPUT

PT100, C, J, K, N, R, S, T

6 STATUS LEDs

DS.PLUS.TWPH-1UT.E01E

TECHNICAL SPECIFICATIONS

RADIO SPECIFICATIONS	868MHZ	915MHZ
Range ¹	Up to 4 Km LoS	
Frequency band ²	868 to 869 MHz	902 to 928 MHz ³
Number of channels	16	50 ⁴
Reception sensivity ²	-97 to -110 dBm	
Transmit power ²	25 to 27 dBm	8 to 27 dBm
Radio transmission rate ²	19 to 76,8 kbit/s	
Encryption method	AES 128(Advanced Encryption Standard)	
Modulation	GFSK	
Antenna connector	SMB	
Antenna	Articulated dipole antenna	
Antenna impedance	50	

WIRELESS NETWORK	
Maximum devices	55
Maximum hops	13
Communication period	1 to 43200 seconds (configurable)

INPUT RESISTANCE THERMOMETER (RTD)	
Measured variable	Temperature
Sensor type	PT100
Units	°C
Connection	1 Resistance thermometer (RTD) in 2-wire, 3-wire or 4-wire system
Sensor current	200µA
Open-circuit monitoring	Always active (cannot be disabled)
Short-circuit monitoring	Always active (cannot be disabled)
Measuring range	See "Digital measuring accuracy" table
Cable resistance per wire (max.)	50 Ω

INPUT THERMOCOUPLES (TC)	
Measured variable	Temperature
Sensor type	Thermocouples: C, J, K, N, R, S, T
Units	°C
Connection	1 Thermocouple
Open-circuit monitoring	Always active (cannot be disabled)
Short-circuit monitoring	Not available
Cold junction compensation (CJC)	Integrated resistance thermometer
Measuring range	See "Digital measuring accuracy" table

POWER SUPPLY	
Voltage Range	5 to 24V DC
Measurement accuracy	± 50mV
Power consumption (sleep)	22 µA @ 12V DC

Protection	Against reversed polarity
------------	---------------------------

MEASUREMENT ACCURACY

Reference conditions	
Power supply	12V DC ± 1%
Ambient temperature	23°C
Digital measuring errors	See table "Digital measuring accuracy" table
Internal cold junction	
Accuracy	< ± 0,50 °C
Resolution	0,01 °C
Influence of ambient temperature	
on RTD measurement	< ± 0,001 °C / °C
on thermocouple	Thermocouples C, J, K, N, T: ≤ ± 0,005 °C / °C Thermocouple R: ≤ ± 0,010 °C / °C Thermocouple S: ≤ ± 0,2 °C / °C
EMC - immunity influence (IEC 61326-1)	[To Be Defined]

OPERATING ENVIRONMENT

Ambient temperature range	-40 to 80°C
Storage temperature range	-40 to 80°C
Relative humidity	≤95%, without condensation

FACTORY DEFAULT SETTINGS

	868MHZ	915MHZ
Frequency	869,525MHz	915,000MHz
Radio transmit power		27dBm
Radio transmission rate		76,8kbit/s
Wireless channel	13	26
Wireless network ID		13042017
Communication period		10 seconds
Reconnection period		30 minutes
Gateway modbus index		1
Operating mode		End Device
Transmitter description		TekOnElectronics
Sensor type		PT100 3W

CASING

Material	Nylon 66
Weight	Approx. 50g
Dimensions	See "Dimensional drawings"
Cross section	2,5 mm
Protection type	IP40

CERTIFICATIONS AND APPROVALS

EN 61326-1 - Class B - Industrial Requirements
EN 300 220-2 V3.1.1
EN 301 489-1 V2.2.1

EN 60950-1:206

EN 61326-1:2013

ETSI EN 301 489-1 V1.9.2

¹ Range depends on the RF propagation environment and Line of Sight (LoS). Always verify your wireless network's range by performing a Site Survey.

² Dependent on radio channel selection.

³ In some countries, the frequency band admitted is not so extended as the default range.

⁴ The radio frequencies admitted in Australia are available from channel 26 to channel 50.

DIGITAL MEASURING ACCURACY

RESISTANCE THERMOMETER (RTD)

Sensor	Range °C	Accuracy °C	Resolution °C
PT100	-210 to 850	< ± 0,2	0,05

THERMOCOUPLES (TC)

Sensor	Range °C	Accuracy °C	Resolution °C
C	0 to 2300	< ± 1,0	0,400
J	-210 to 1200	< ± 1,0	0,077
K	-270 to 1370	< ± 1,0	0,098
N	-270 to 1270	< ± 1,0	0,151
R	-50 to 1760	< ± 1,2	0,189
S	-50 to 1760	< ± 2,0	0,185
T	-270 to 400	< ± 1,0	0,026

TECHNICAL DRAWINGS AND INFORMATION

ELECTRICAL CONNECTIONS

RESISTANCE THERMOMETER

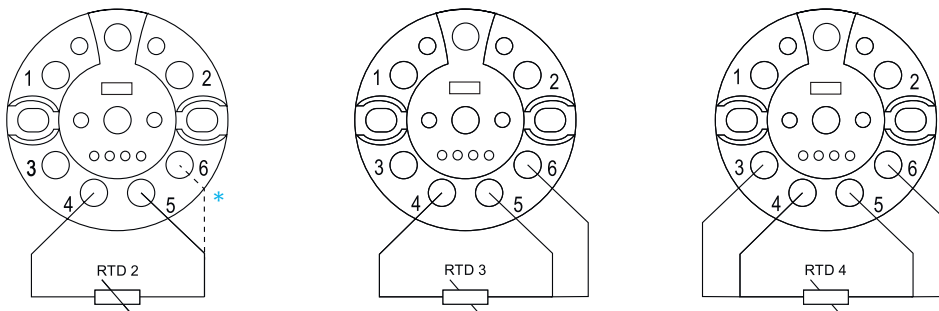

THERMOCOUPLE

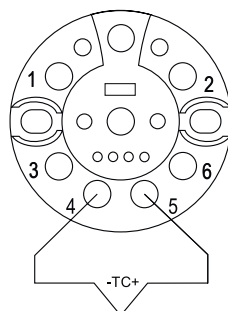

POWER SUPPLY

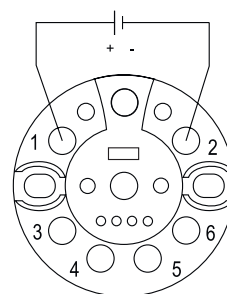

* The 2-wire connection requires an electrical connection between screw 5 and screw 6

DIMENSIONAL DRAWINGS

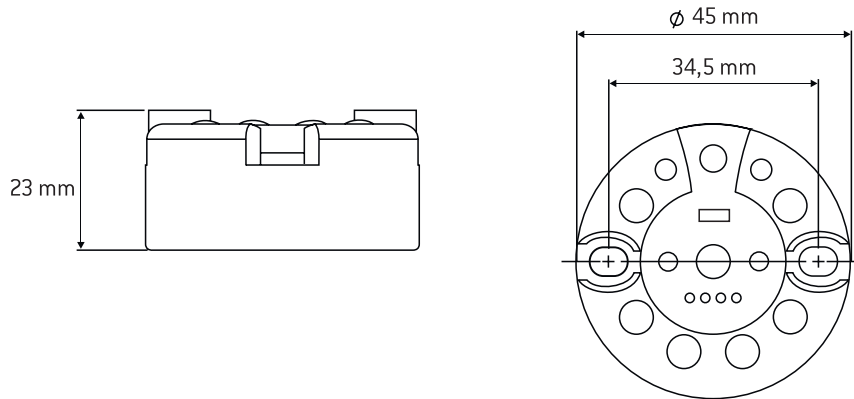

OPERATIONS BUTTON ACTIONS

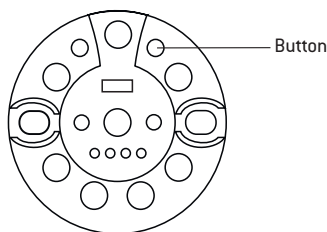

OPERATION	ACTION*	DESCRIPTION
SITE SURVEY	PRESS 3 seconds to enter/exit	- Transmitter will perform a site survey; - Red LED and green LED stay on; - RSSI power level is indicated by the 4 blue LEDs;
LOAD DEFAULT SETTINGS	PRESS 10 seconds	- Transmitter will load the default settings; - The 4 blue LEDs will light up gradually until the operation be completed;

STATUS LED

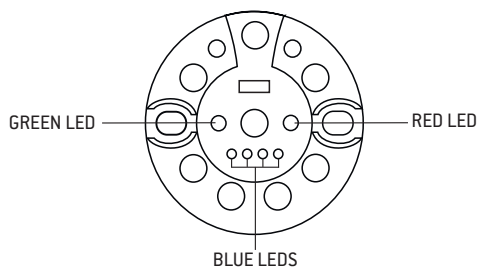

GREEN AND RED LEDS	BLUE LEDS	DESCRIPTION
ON	BLINK EVERY SECOND	- Transmitter in Configuration Mode;
RED LED BLINK	OFF	- Quit Configuration Mode and starting connection to the gateway;
FLASH ALTERNATELY 1 MINUTE	OFF	- Connected to the gateway; - After 1 minute, LEDs go off;
OFF	OFF	- Transmitter in Sleep/Normal Mode;
RED LED BLINK OVER 1 MINUTE	OFF	- Transmitter did not connect to the gateway; - It will continue to try to establish communication;

* Operations button has only two possible actions. Any action beside the documented will have no effect on the transmitter

RELATED PRODUCTS



WGW420 WIRELESS MODBUS GATEWAY 868 MHZ / 915 MHZ WITH 8 ANALOG OUTPUTS

REF.: PA164510210 / PA164510220

- Supports up to 55 devices;
- Up to 4 Km communication distance (LoS);
- 1sec network refresh time;
- RS485 interface with Modbus protocol;
- 8 Analog Outputs;
- Transmitters battery status and RF link quality information;
- Configurable over USB;
- DIN rail mounting.



PLUS WRP001 WIRELESS REPEATER 868 MHZ / 915 MHZ

REF.: PA164510310 / PA164510320

- Up to 12 repeaters in series for extra-long range;
- Extra repeaters for network redundancy and robustness;
- Up to 4 Km communication distance (LoS) with 868 MHz/915 MHz;
- Multi-hop mesh network with self-forming, self-healing and self-optimizing features;
- Simple and intuitive USB configuration via Tekon Configurator (free software).

REVISION HISTORY

VERSION	
E01B	Inclusion of information about the frequency range used in Australia.
E01C	Revision of "Certifications and Approvals" table.
E01E	Inclusion of Reconnection Period on "Factory Default Settings Table"

© BRESIMAR AUTOMAÇÃO, S.A.

All rights reserved.

The contents of this document (texts, images, brands, corporate image, trade name, designs, methodological and product descriptions, among others), as well as its structure and design, are owned by Bresimar Automação, SA (herein in referred to as Bresimar) or, it has legitimacy for its use, being strictly prohibited the modification, exploitation, reproduction, communication to third parties or distribution of all or part of the contents of this document, without the prior express written consent of Bresimar .

Bresimar will not be liable for any claim, loss or damages resulting from or arising from a cause over which Bresimar has no control, whether by acts or omissions, breach of contract or non-compliance with applicable laws by the Supplier , as well as incidents caused by the client's systems.

TEKON ELECTRONICS
a brand of Bresimar Automação S.A.

Quinta do Simão
3800-230 Aveiro
PORTUGAL

P.: +351 234 303 320
M.: +351 933 033 250
E.: sales@tekonelectronics.com

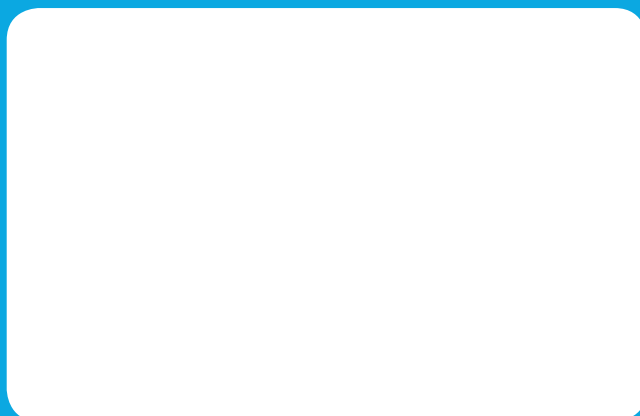

Cofinanciado por:



UNIÃO EUROPEIA
Fundo Europeu
de Desenvolvimento Regional